

Tavola™ Baffle Ceiling System

The Hunter Douglas Baffle ceiling system ensures a perfect linear appearance whilst delivering excellent acoustic performance. Baffle Ceiling Systems are ideal for areas with high noise level or where improved acoustics are required such as schools, gymnasias, shopping malls and transport hubs.

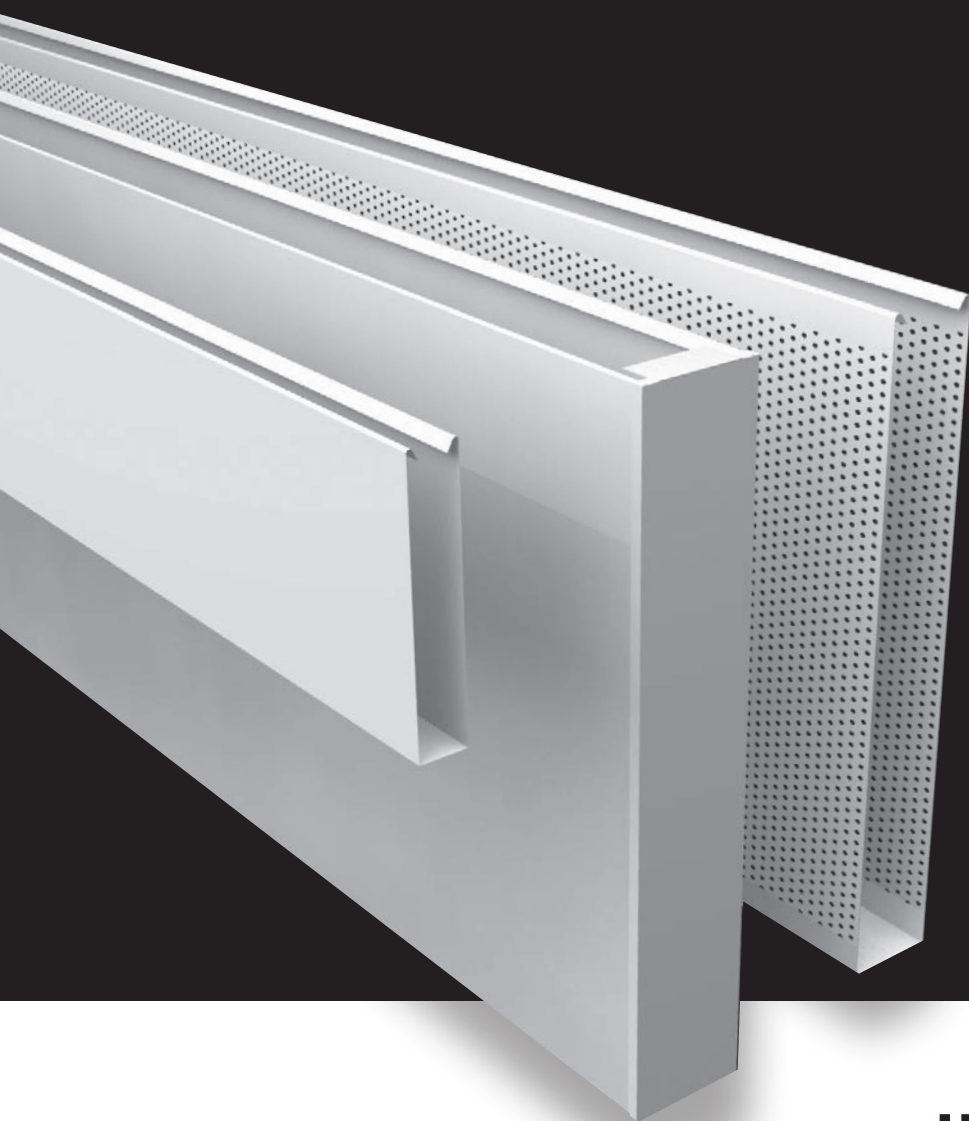

HunterDouglas 
Architectural



Tavola™ Baffle Ceiling Systems

Creating spacious environments

FLEXIBLE BY DESIGN

The Hunter Douglas Baffle ceiling system provides the designer with a range of creative opportunities. Our wide variety of products, colours, and finishes can be combined to create dramatic, high-quality ceilings.

Baffles are engineered to dimensionally define the ceiling plane. Consisting of vertically hung, 'floating' panels, they can create unique visual patterns without compromising the sense of space.

Although Baffle ceiling systems are designed to mask the plenum, they also provide easy access for the efficient installation and maintenance of climate control, audio, lighting and fire sprinkler systems.

ACOUSTIC PERFORMANCE

The Tavola™ Baffle Ceiling System combines comfort with performance. Public spaces, airports, trains stations and shopping malls can all reduce noise pollution and reverberation issues with a dynamically designed Tavola™ ceiling system.

For increased acoustic performance, a non-woven tissue can be inserted into the baffle.



Tavola™ Baffle ceilings from Hunter Douglas are ideal for visually reducing room height while maintaining original room volume.

Tavola™ Baffle ceilings excel at diffusing daylight or artificial light entering from above.

At a minimum viewing angle of approximately 45 degrees, the ceiling has a closed appearance.

FIRE BEHAVIOUR

Metal Baffle ceilings from Hunter Douglas are fully tested for reaction to fire, and are classified A2,s1,d0 and A2,s2,d0 according to EN 13501-1 and will therefore not contribute to a fire. When ceilings need to protect the structural integrity of the building, Hunter Douglas offer a range of practical and tested solutions for enhanced fire stability.

Further information is available on request.
www.hunterdouglasarchitectural.eu

CONTENT	Page
Tavola™ Straight Baffle ceiling	2
Tavola™ Levels Baffle ceiling	3
Tavola™ Divergent Baffle ceiling	4
Acoustics	5
Material specifications	7
Hunter Douglas Architectural	8

Designed to work for you



Production by
 Hunter Douglas
 Ceiling Center



HunterDouglas

Tavola™ Straight Baffle ceiling

BAFFLES

The Tavola™ Levels Baffle ceiling system is a lightweight, floating ceiling and consists of box-shaped panels. The baffles are available in a wide range of materials, colours and designs, including wood décor and steel. The baffles are made to measure and available in any length up to 4000 mm.

SUSPENSION

The Baffle FE carrier (4) is black and is provided with prongs to accommodate the baffles in a custom made module. Carriers have a standard length of ± 3000 mm (depends on the module).

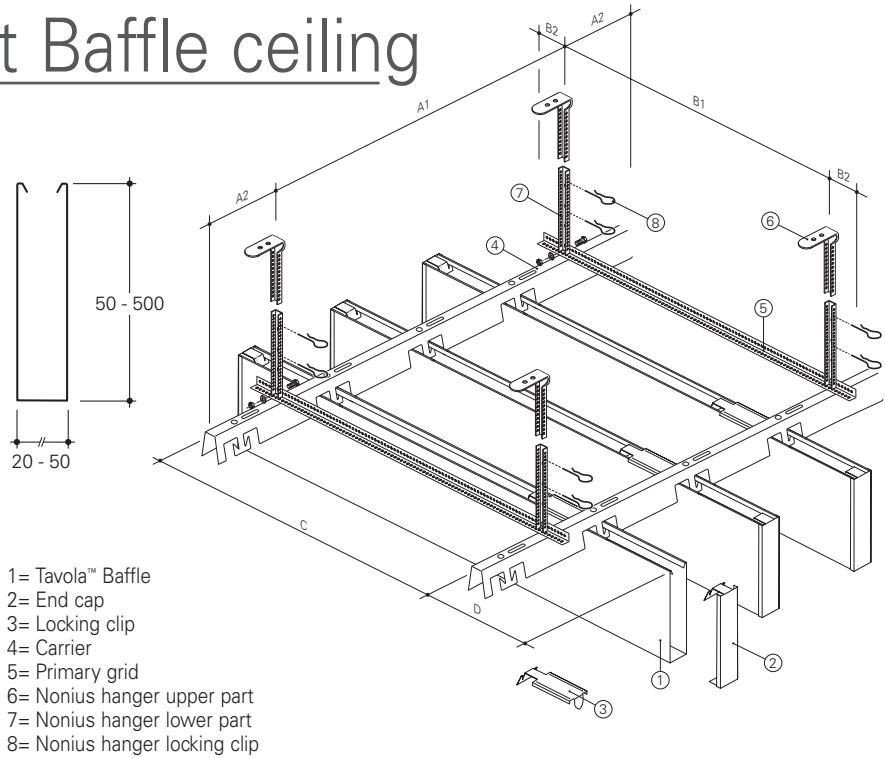

CONSTRUCTION DETAILS

The Baffle ceiling system is a modular sized system that provides in open spaces between the baffles for a smooth integration of technology. Climate control, lighting, sprinklers, smoke detectors, speaker and security systems can all be installed and maintained with ease.

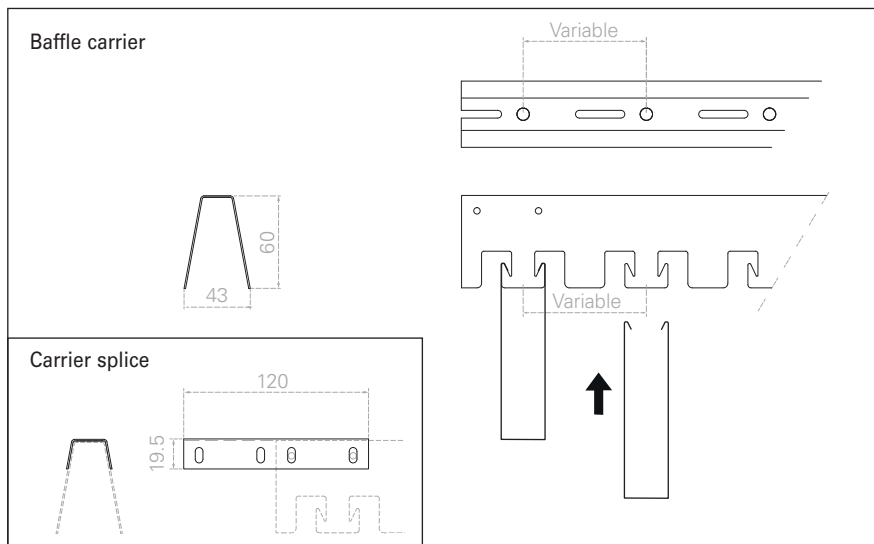

MAXIMUM SPANS

Baffle type	Carrier Span (mm)		Panel Span (mm)			
	A1	A2	B1	B2	C	D
50	*	300	1500	300	1500	150

*For maximum carrier spans see the table and graph on page 5

DIMENSIONS

The baffles are made to measure in any length from 600 mm up to 4000 mm.

* Panels > 4000 mm available on request with a maximum of 5000 mm.

Baffle width (mm)	Min. height (mm)	Max. height (mm)	Min. length (mm)	Max. length (mm)
20	70	300	600	4000*
20	70	400	600	3000
30	60	300	600	4000*
30	60	400	600	3000
30	60	500	600	2000
40	60	300	600	4000*
40	60	400	600	3000
40	60	500	600	2000
50	50	300	600	4000*
50	50	400	600	3000
50	50	500	600	2000

Tavola™ Levels Baffle ceiling

BAFFLES

Hunter Douglas Tavola™ Levels Baffles incorporate different baffle heights in one system, allowing the designer to create a unique rhythm or playful landscape to the ceiling surface.

SUSPENSION

The Baffle FE carrier (4) is black and is provided with prongs to accommodate the baffles in a custom made module. Carriers have a standard length of ± 3000 mm (depends on the module).

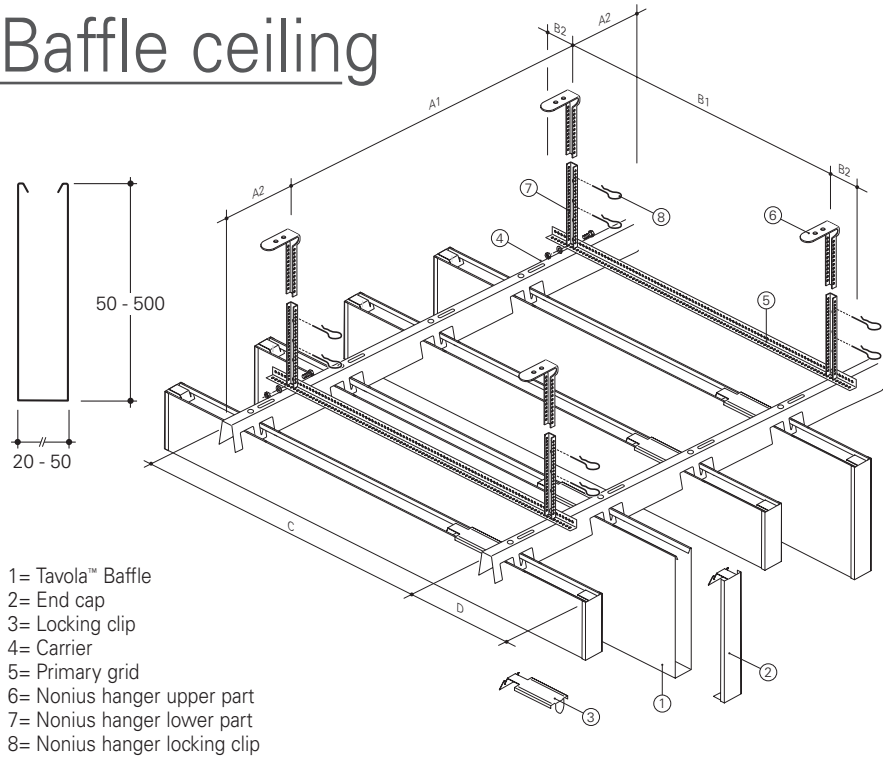

- 1= Tavola™ Baffle
- 2= End cap
- 3= Locking clip
- 4= Carrier
- 5= Primary grid
- 6= Nonius hanger upper part
- 7= Nonius hanger lower part
- 8= Nonius hanger locking clip

CONSTRUCTION DETAILS

The Baffle ceiling system is a modular sized system that provides an open space between the baffles for an easy integration of technology.

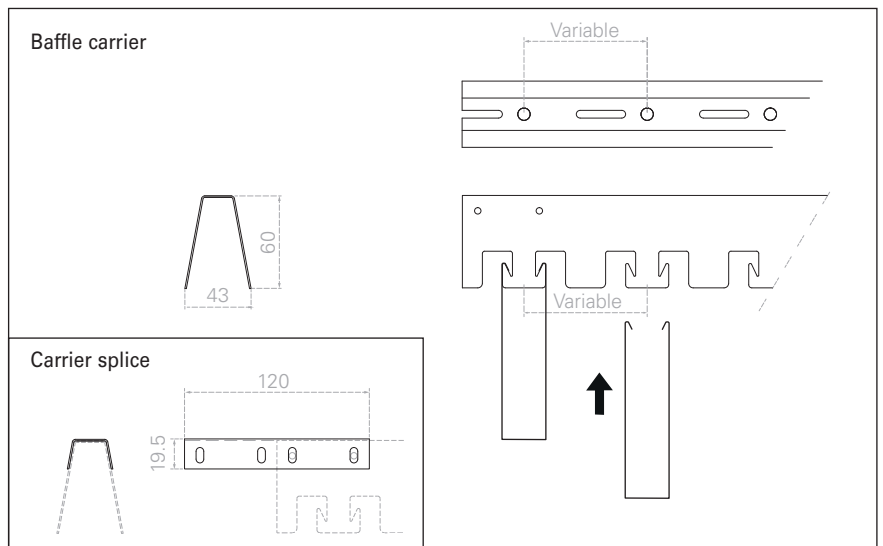

MAXIMUM SPANS

Baffle type	Carrier Span (mm)		Panel Span (mm)			
	A1	A2	B1	B2	C	D
50	*	300	1500	300	1500	150

*For maximum carrier spans see the table and graph on page 5

DIMENSIONS

The baffles are made to measure in any length from 600 mm up to 4000 mm.

* Panels > 4000 mm available on request with a maximum of 5000 mm.

Baffle width (mm)	Min. height (mm)	Max. height (mm)	Min. length (mm)	Max. length (mm)
20	70	300	600	4000*
20	70	400	600	3000
30	60	300	600	4000*
30	60	400	600	3000
30	60	500	600	2000
40	60	300	600	4000*
40	60	400	600	3000
40	60	500	600	2000
50	50	300	600	4000*
50	50	400	600	3000
50	50	500	600	2000

Tavola™ Divergent Baffle ceiling

BAFFLES

Non-parallel, diverging beams and baffles create organic textures in an unlimited variety of configurations for interior applications. Tavola™ Divergent Baffles create contemporary movement without the traditional lines.

SUSPENSION

The Baffle FE carrier (4) is black and provided with holes to attach the baffle through a locking plate. Carriers have a standard length of 3000 mm.

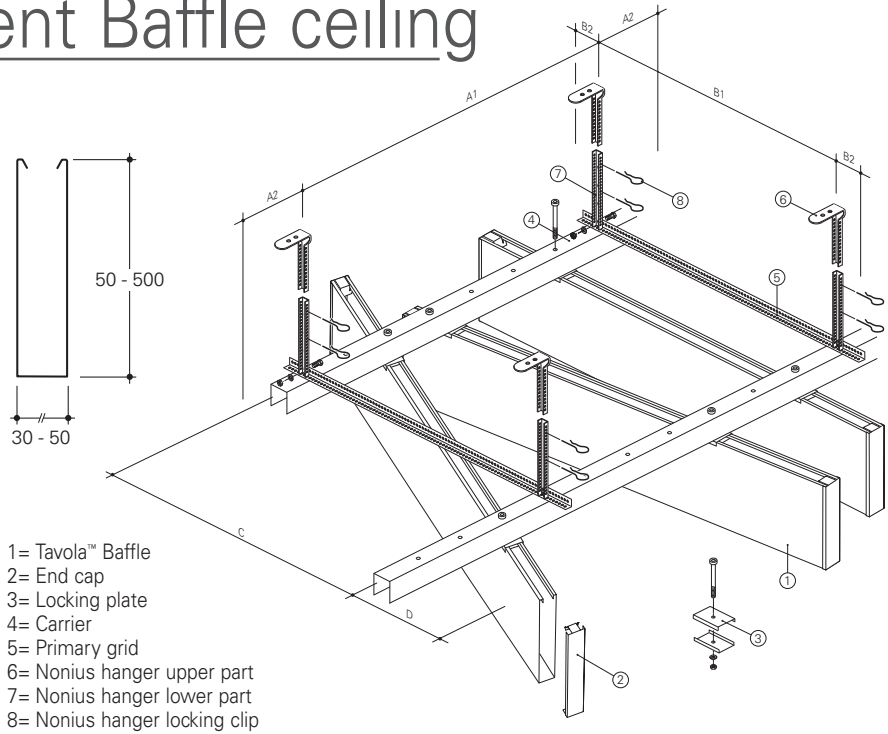

- 1= Tavola™ Baffle
- 2= End cap
- 3= Locking plate
- 4= Carrier
- 5= Primary grid
- 6= Nonius hanger upper part
- 7= Nonius hanger lower part
- 8= Nonius hanger locking clip

CONSTRUCTION DETAILS

The Baffle ceiling system is a modular sized system that provides in open spaces between the baffles for an easy integration of technology.

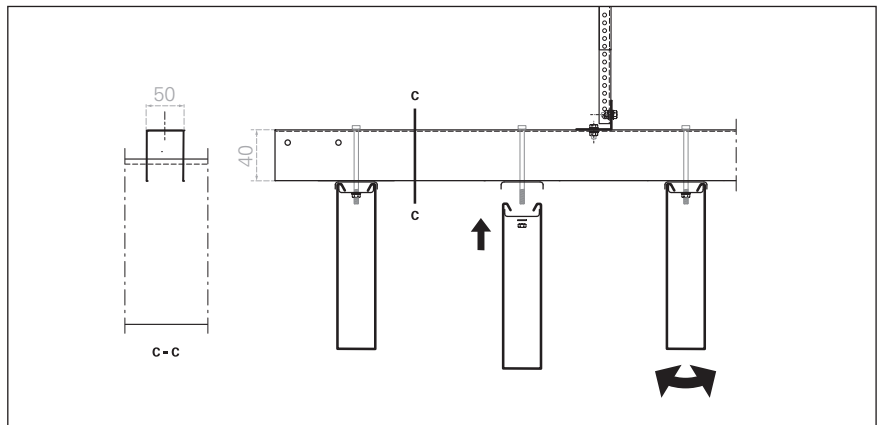

MAXIMUM SPANS

Baffle type	Carrier Span (mm)		Panel Span (mm)			
	A1	A2	B1	B2	C	D
50	*	300	1500	300	1200	150

*For other maximum carrier spans see the table and graph on page 5

DIMENSIONS

The baffles are made to measure in any length from 600 mm up to 4000 mm.

* Panels > 4000 mm available on request with a maximum of 5000 mm.

Baffle width (mm)	Min. height (mm)	Max. height (mm)	Min. length (mm)	Max. length (mm)
30	60	300	600	4000*
30	60	400	600	3000
30	60	500	600	2000
40	60	300	600	4000*
40	60	400	600	3000
40	60	500	600	2000
50	50	300	600	4000*
50	50	400	600	3000
50	50	500	600	2000

Maximum spans

TAVOLA™ BAFFLE WEIGHT/M²

Calculate the weight of the Baffle per m² and determine the number of carriers and suspension points with the formulæ on the right.

TAVOLA™ BAFFLE WEIGHT/M² FORMULE

- Amount baffles = 1000/module
- Weight m² = amount baffles x weight /m¹
- Q-load kg/m¹ = load m² x panel span (C)

TAVOLA™ BAFFLE WEIGHT/M¹

Baffle Width (mm)	Baffle Height (mm)	FE 0.6 mm Kg/m ¹	ALU 0.8 mm Kg/m ¹
30	100	1.14	0.54
30	150	1.60	0.76
30	200	2.07	0.98
30	250	2.54	1.20
30	300	3.01	1.42
40	100	1.18	0.56
40	150	1.65	0.78
40	200	2.12	1.00
40	250	2.59	1.22
40	300	3.06	1.44
50	100	1.23	0.58
50	150	1.70	0.80
50	200	2.17	1.02
50	250	2.63	1.24
50	300	3.10	1.46

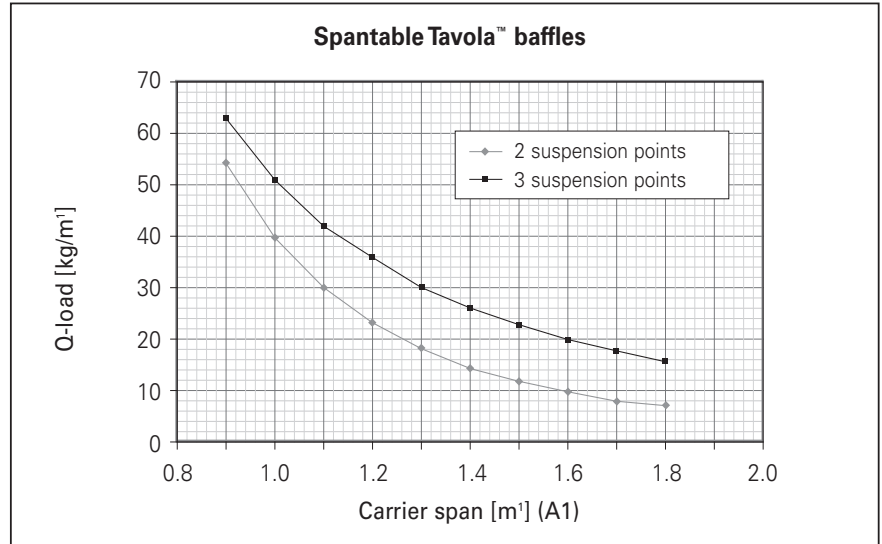

Acoustics

PERFORATION PATTERNS

In order to improve interior sound control, the Tavola™ Baffles can be supplied perforated. As a standard feature, perforated panels are supplied with a sound absorbing non-woven tissue glued into the Baffle for enhanced acoustical performance.

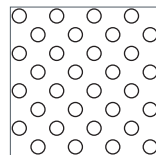

D1522
Ø 1.5 mm
↑ 4 ↔ 4
Openness 22%

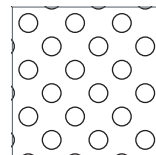

D2022
Ø 2 mm
↑ 5 ↔ 5
Openness 22%

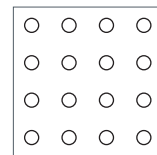

R1511
Ø 1.5 mm
↑ 4 ↔ 4
Openness 11%

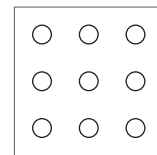

R2011
Ø 2 mm
↑ 5 ↔ 5
Openness 11%

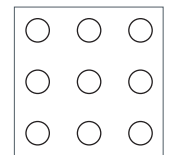

R2516
Ø 2.5 mm
↑ 5.5 ↔ 5.5
Openness 16%

Standard patterns shown.

PLAIN BORDERS

Baffles have a nominal plain border of 10 mm.

Standard Perforation

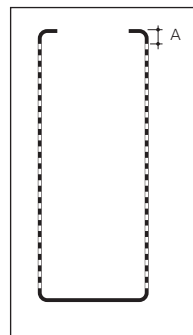

A = 10 mm
Height: max. 300 mm
Panels >300 mm
on request with a maximum of 500 mm

On request

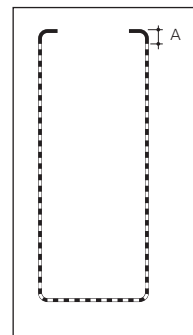

A = 10 mm
D1522

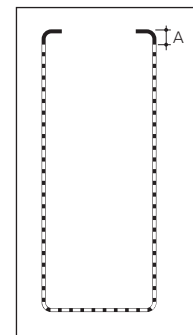

A = 10 mm
D2022

SOUND ABSORPTION DATA

Tavola™ Straight Baffles

Baffle dimensions 30 x 200 mm, spacing 150 mm ctc. Perforated with Ø1.5 mm holes. The baffles are provided with black non-woven tissue glued over the whole perforated area. Plenum depth is 0 mm.

With post painted products the openness will decrease due to paint thickness.

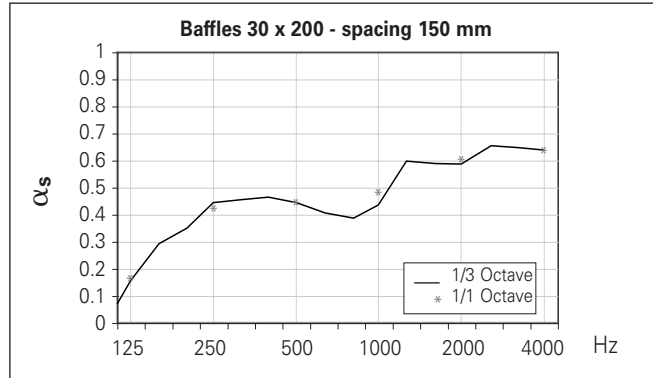

Tested by Peutz; test report no: A 3144-1E-RA.

Freq. Hz.	125	250	500	1000	2000	4000	α_w	NRC
1/1 Octave	0.17	0.42	0.44	0.48	0.61	0.64	0.50	0.50

Tavola™ Straight Baffles

Baffle dimensions 30 x 200 mm, spacing 200 mm ctc. Perforated with Ø1.5 mm holes. The baffles are provided with black non-woven tissue glued over the whole perforated area. Plenum depth is 0 mm.

With post painted products the openness will decrease due to paint thickness.

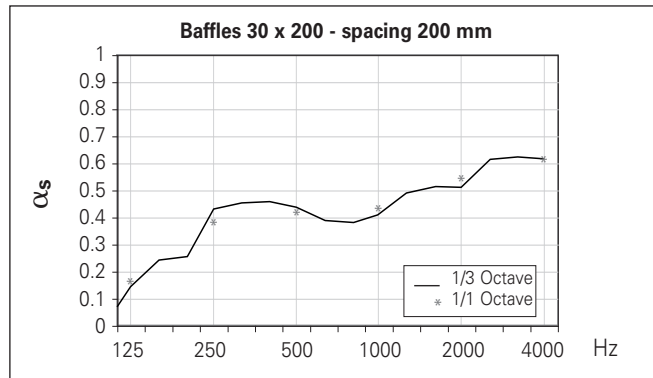

Tested by Peutz; test report no: A 3144-1E-RA.

Freq. Hz.	125	250	500	1000	2000	4000	α_w	NRC
1/1 Octave	0.17	0.39	0.43	0.43	0.55	0.62	0.50	0.45

Tavola™ Straight Baffles

Baffle dimensions 30 x 200 mm, spacing 300 mm ctc. Perforated with Ø1.5 mm holes. The baffles are provided with black non-woven tissue glued over the whole perforated area. Plenum depth is 0 mm.

With post painted products the openness will decrease due to paint thickness.

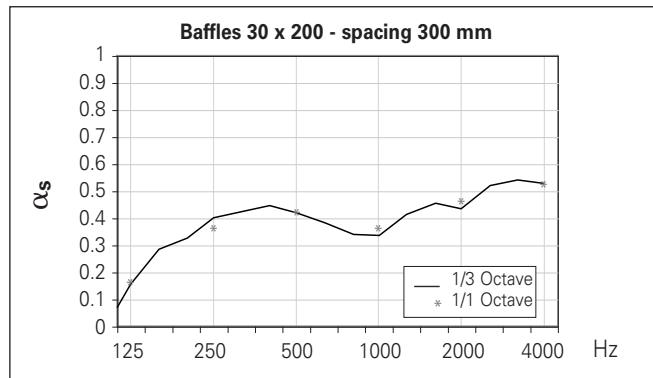

Tested by Peutz; test report no: A 3144-1E-RA.

Freq. Hz.	125	250	500	1000	2000	4000	α_w	NRC
1/1 Octave	0.17	0.37	0.42	0.37	0.47	0.52	0.40	0.40

Acoustics

SOUND ABSORPTION DATA

Tavola™ Straight Baffles

Baffle dimensions 30 x 200 mm, spacing 400 mm etc. Perforated with Ø1.5 mm holes. The baffles are provided with black non-woven tissue glued over the whole perforated area. Plenum depth is 0 mm.

With post painted products the openness will decrease due to paint thickness.

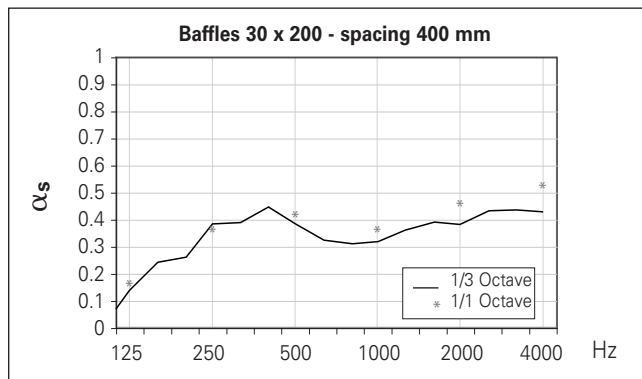

Tested by Peutz; test report no: A 3144-1E-RA.

Freq. Hz.	125	250	500	1000	2000	4000	α_w	NRC
1/1 Octave	0.16	0.35	0.39	0.33	0.41	0.43	0.40	0.35

Tavola™ Straight Baffles

Baffle dimensions 30 x 200 mm, spacing 200 mm etc. Perforated with Ø1.5 mm holes. The baffles are provided with black non-woven tissue glued over the whole perforated area. Plenum depth is 200 mm.

With post painted products the openness will decrease due to paint thickness.

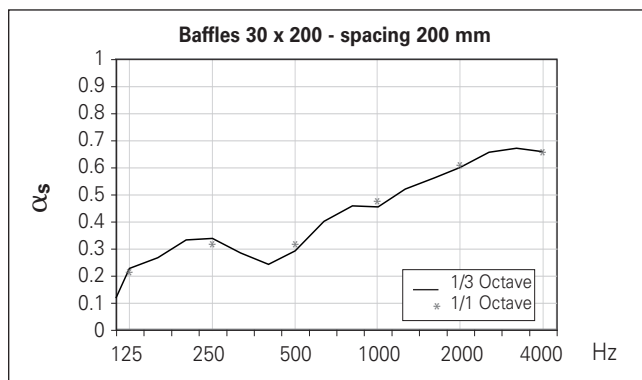

Tested by Peutz; test report no: A 3144-1E-RA.

Freq. Hz.	125	250	500	1000	2000	4000	α_w	NRC
1/1 Octave	0.21	0.32	0.32	0.48	0.61	0.66	0.40	0.45

Material specifications

PHYSICAL DATA

- UV Resistance (RUV2)
- Light reflectance Coefficient:
 - Varies with finish
 - Ral 9010: LR = 0.81
- Corrosion resistance (RC2)

COLOUR RANGE

A wide range of finishes are available including wood décor and steel and baffles can be powder coated in a standard colour or on request in any desired RAL colour.

BIM

Hunter Douglas Ceilings offer a comprehensive REVIT file library for BIM requirements, with resources that support the entire project, from design development, to working drawings, to preconstruction and construction, all the way through to ongoing operations and maintenance. See website for details.

LEED V4 CREDITS

- MR: Building Product Disclosure
- EQ: Low-Emitting Materials
- EQ: Indoor Air Quality Assessment
- EQ: Acoustic Performance

CERTIFICATIONS

- Fire classification plain A2,s1,d0 according en 13501-1
- Fire classification perforated with non-woven A2,s2,d0 according en 13501-1
- Taim qs
- French VOC regulation: class A

HUNTER DOUGLAS

ARCHITECTURAL

For more than 60 years, we've been fortunate enough to help turn countless innovative sketches into innovative buildings. Architects, designers, investors and contractors from around the world have taken advantage of Hunter Douglas' unmatched product development, service and support. Chances are, you've seen more of Hunter Douglas than you think.

Major operation centres in Europe, North America, Latin America, Asia and Australia, we've contributed to thousands of high-profile projects, from retail and commercial facilities to major transit centres and government buildings.

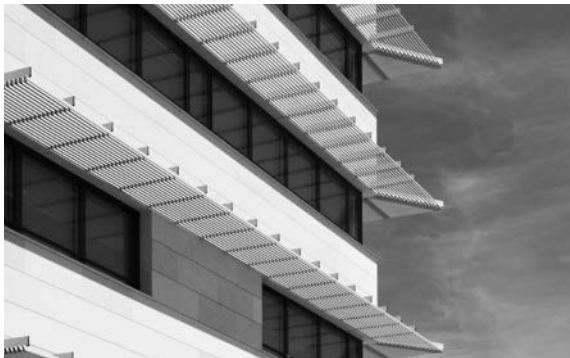

▲ SUN LOUVRES

CEILINGS ▼



▲ CEILINGS

FAÇADES ▼



Not only are the world's architects and designers our partners, they're our inspiration. They continue to raise the bar for excellence. We create products that help bring their visions to life: Ceilings, Sun Louvres and Façades.

Designed
to work for you

© Registered trademark of Hunter Douglas - a HunterDouglas® product Pats. & Pats. Pend. - Technical data subject to change without notice. © Copyright Hunter Douglas 2019. No rights can be derived from copy, text pertaining to illustrations or samples. Subject to changes in materials, parts, compositions, designs, versions, colours etc., even without notice.



HunterDouglas 
Architectural

ARCHITECTURAL SERVICES

We support our business partners with a wide range of technical consulting and support services for architects, developers and installers. We assist architects and developers with recommendations regarding materials, shapes and dimensions, colours and finishes.

We also help with the creation of design proposals, visualisations, and installation drawings. Our services to installers range from providing detailed installation drawings and instructions to training installers and advising on the building site.



Learn More

- Contact our Sales office
- www.hunterdouglasarchitectural.eu



Printed on
EU Ecolabel
certified paper



Hunter Douglas products and solutions are designed to improve indoor environmental quality and conserve energy, supporting built environments that are comfortable, healthy, productive, and sustainable.



Our paint and aluminium melting processes are considered to be one of the industry standards in terms of clean production processes. All aluminium products are 100% recyclable at the end of their lifecycle.

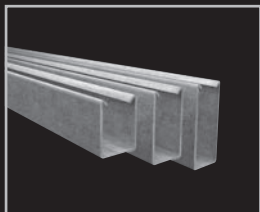

HeartFelt® Linear

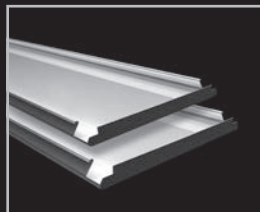

Wide Panel

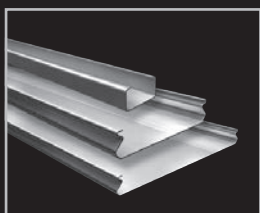

Linear

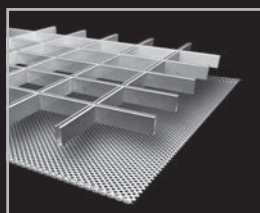

Cell | Stretch metal



Baffles

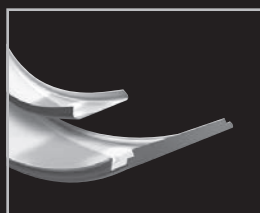

Curved

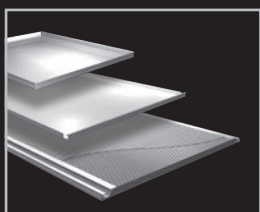

Tiles | Planks | XLnt

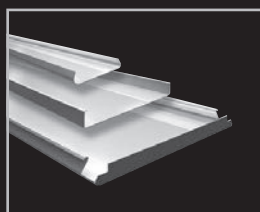

Exterior

Belgium
Bulgaria
Croatia / Slovenia
Czech Republic
Denmark
France
Germany
Greece
Hungary
Italy
The Netherlands
Norway
Poland
Portugal
Romania
Russia
Serbia
Slovakia
Spain
Sweden
Switzerland
Turkey
United Kingdom
Africa
Middle East

Asia
Australia
Latin America
North America

Hunter Douglas Architectural

Piekstraat 2
P.O. Box 5072 - 3008 AB Rotterdam
The Netherlands
Tel. +31 (0)10 - 486 99 11
Fax +31 (0)10 - 484 79 10
www.hunterdouglasarchitectural.eu