

Motorized system

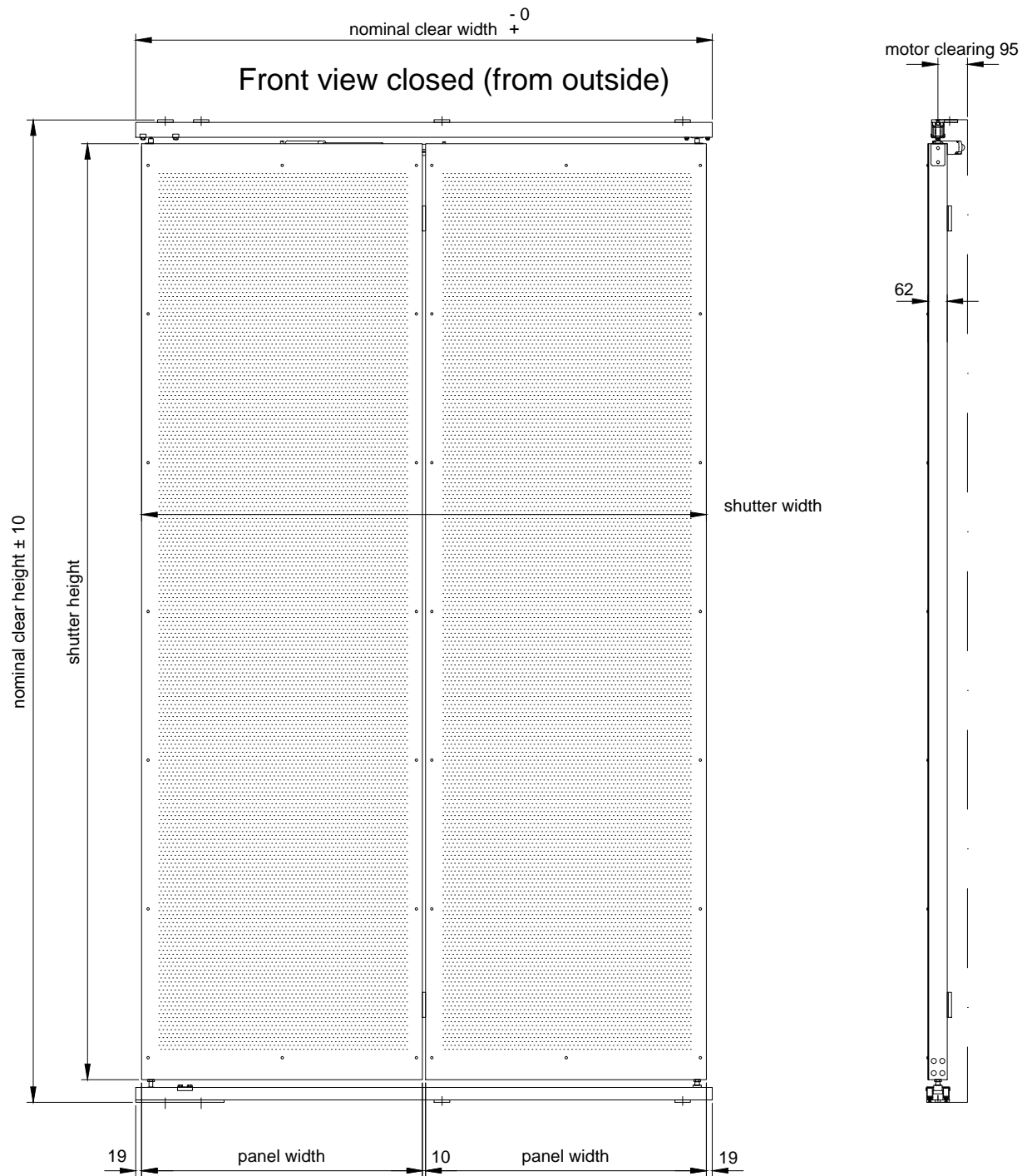

HunterDouglas

HUNTER DOUGLAS EUROPE B.V.

Architectural Projects

Window Coverings

Ceilings

Sun Control

Façades

Drwg.No.

SC-FS-SHEET-2D-01

Subject: Folding shutter / motor / sheet view outside

Date:

11.11.2014

Size:

A4

Scale:

1:20

Rev:

00

Top view closed

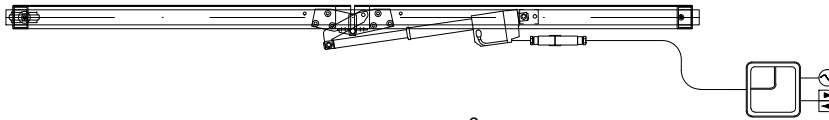

nominal clear width -0
+

Front view closed (from inside)

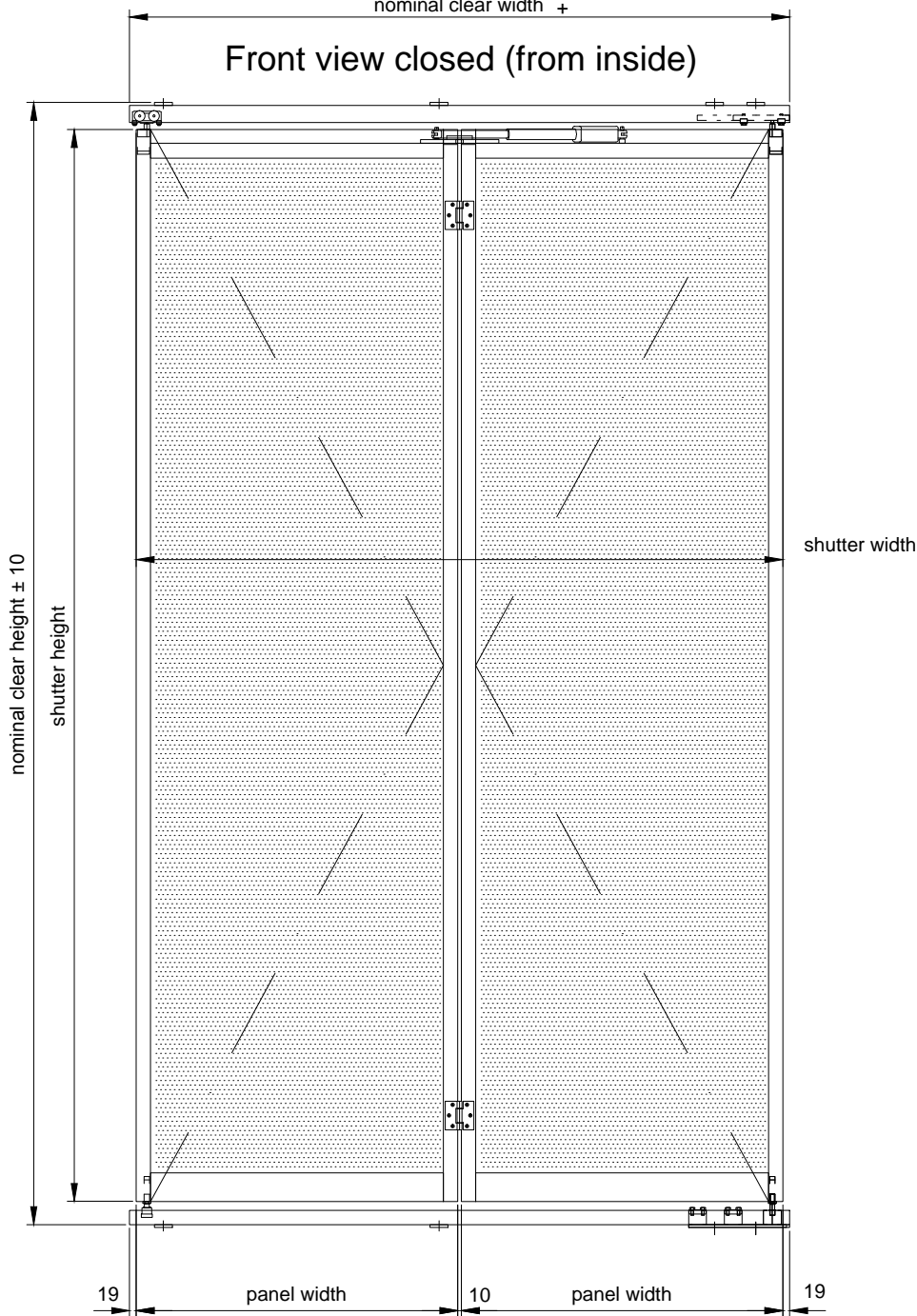

Section



Top view bottom rail

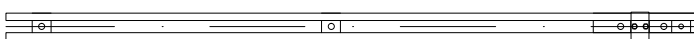

HunterDouglas

HUNTER DOUGLAS EUROPE B.V.

Architectural Projects

Window Coverings

Ceilings

Sun Control

Façades

Drwg.No.

SC-FS-SHEET-2D-02

Subject: Folding shutter / motor / sheet / closed

Date:

11.11.2014

Size:

A4

Scale:

1:20

Rev:

00

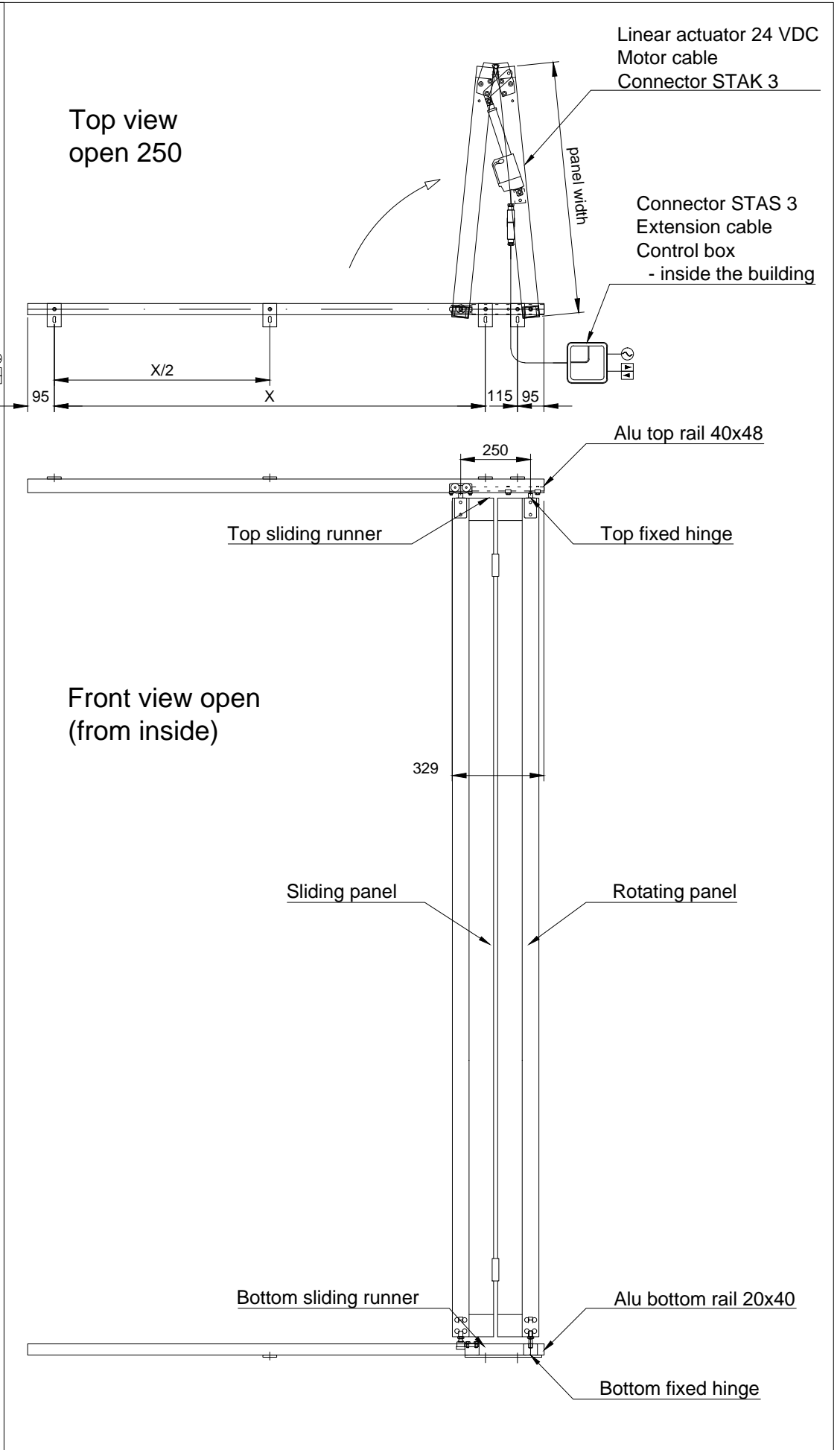
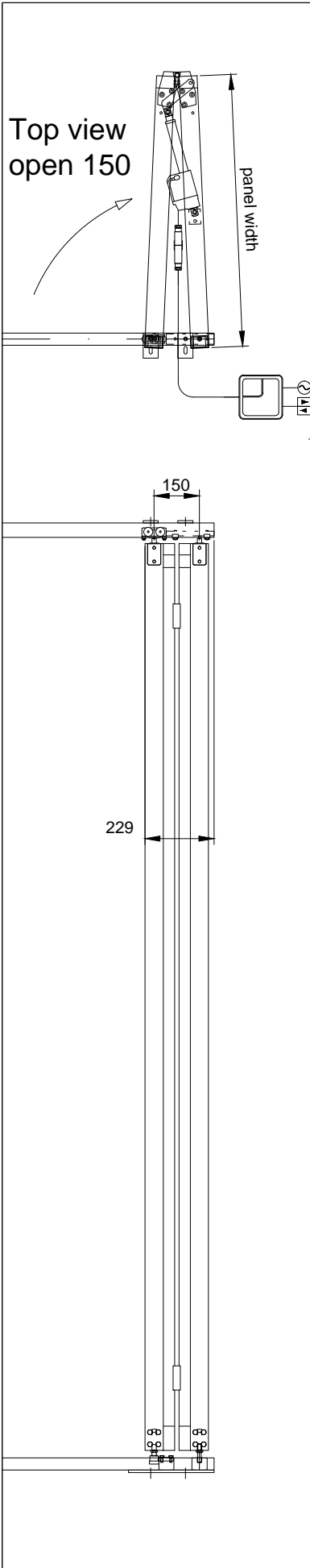

HunterDouglas

HUNTER DOUGLAS EUROPE B.V.

Architectural Projects

Window Coverings

Ceilings

Sun Control

Façades

Drwg.No.

SC-FS-SHEET-2D-03

Subject: Folding shutter / motor / sheet / open

Date:

11.11.2014

Size:

A4

Scale:

1:20

Rev:

00

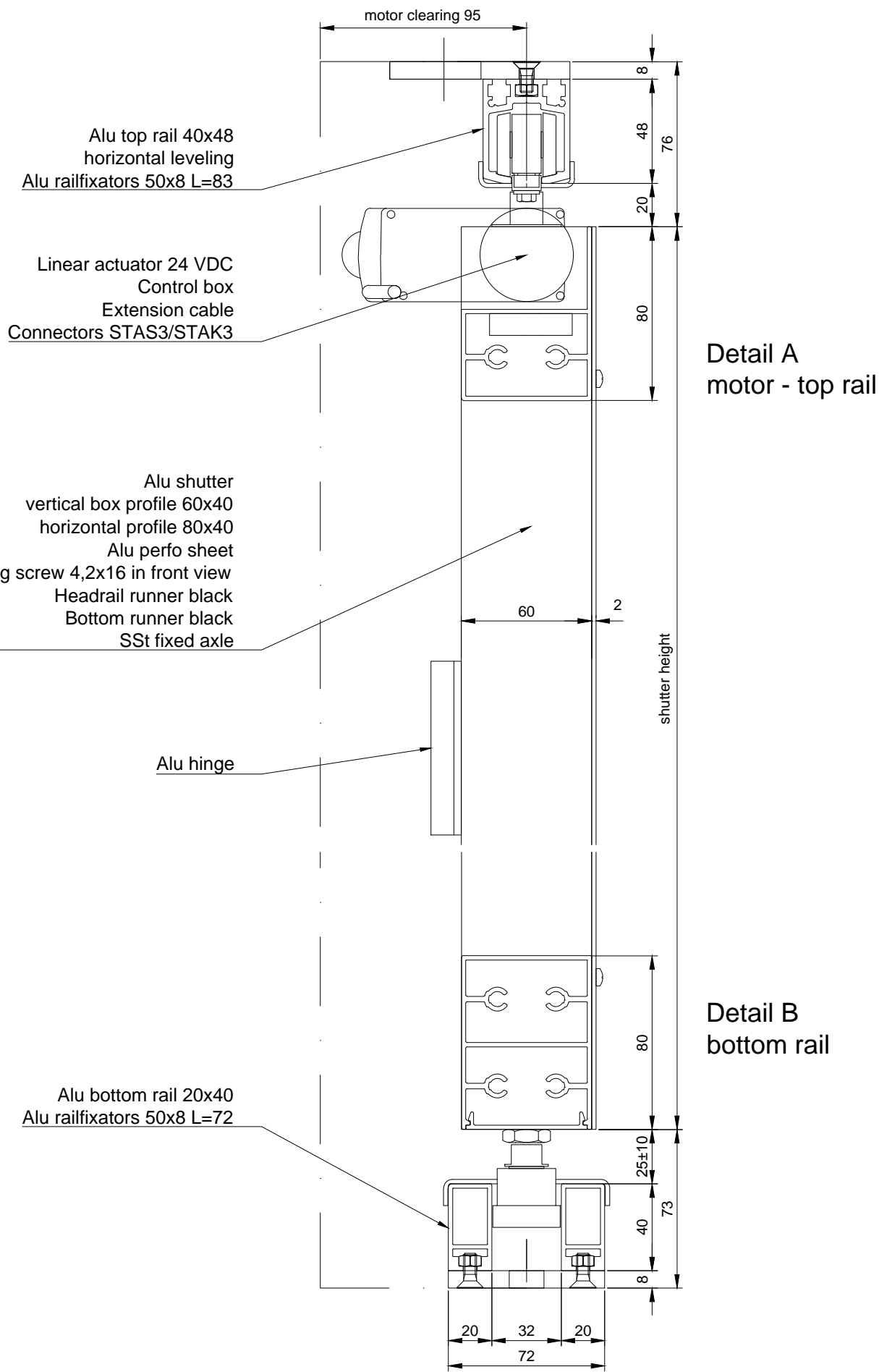

HunterDouglas

HUNTER DOUGLAS EUROPE B.V.

Architectural Projects

Window Coverings

Ceilings

Sun Control

Façades

Drwg.No.

SC-FS-SHEET-2D-04

Subject: Folding shutter / motor / sheet details

Date:

11.11.2014

Size:

A4

Scale:

1:2,5

Rev:

00

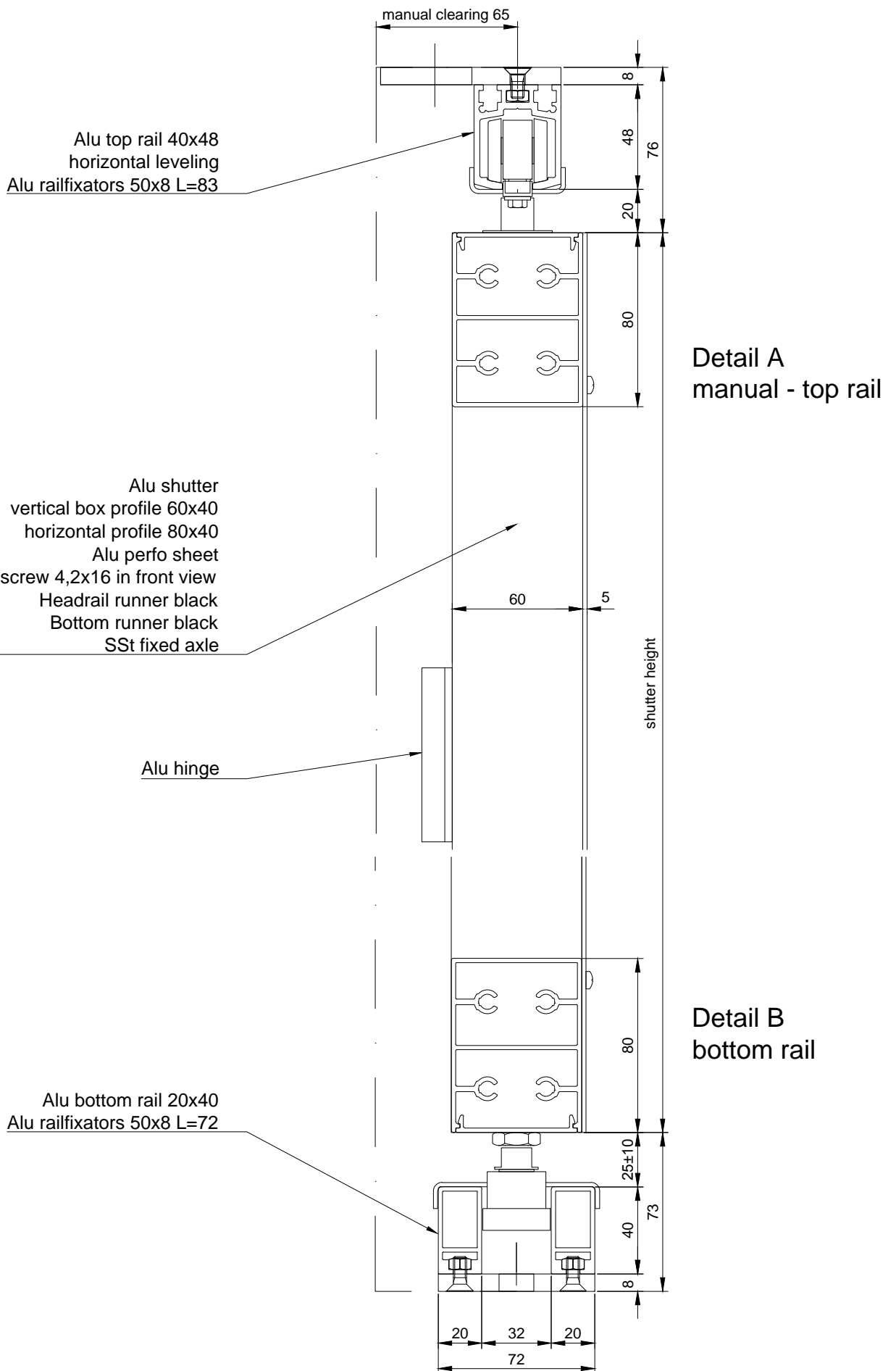

HunterDouglas

HUNTER DOUGLAS EUROPE B.V.

Architectural Projects

Window Coverings

Ceilings

Sun Control

Façades

Drwg.No.

SC-FS-SHEET-2D-05

Subject: Folding shutter / manual / sheet details

Date:

11.11.2014

Size:

A4

Scale:

1:2,5

Rev:

00

Perforation A:
R 2,5 - Z10x10
opening 5%

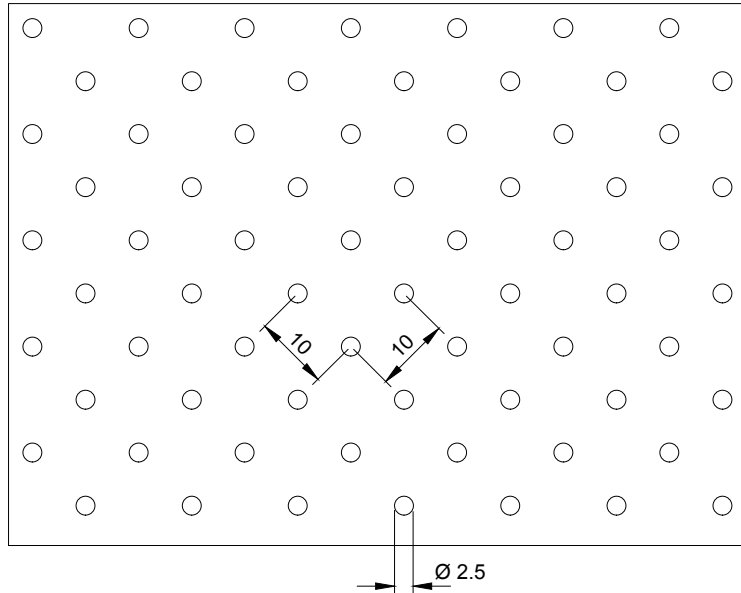

Perforation B:
R 3,5 - Z10x10
opening 10%

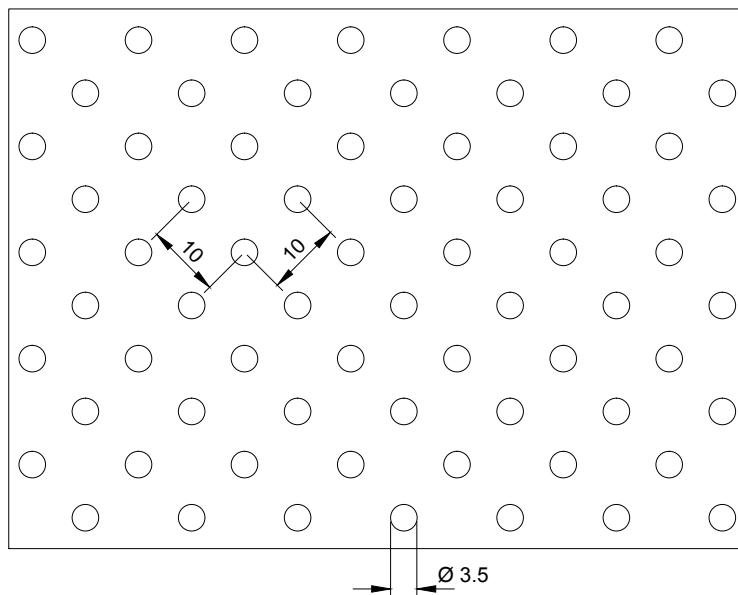

HunterDouglas

HUNTER DOUGLAS EUROPE B.V.

Architectural Projects

Window Coverings

Ceilings

Sun Control

Façades

Drwg.No.

SC-FS-SHEET-2D-06

Subject: Folding shutter / perforation sheet

Date:

11.11.2014

Size:

A4

Scale:

1:1

Rev:

00

Manual system

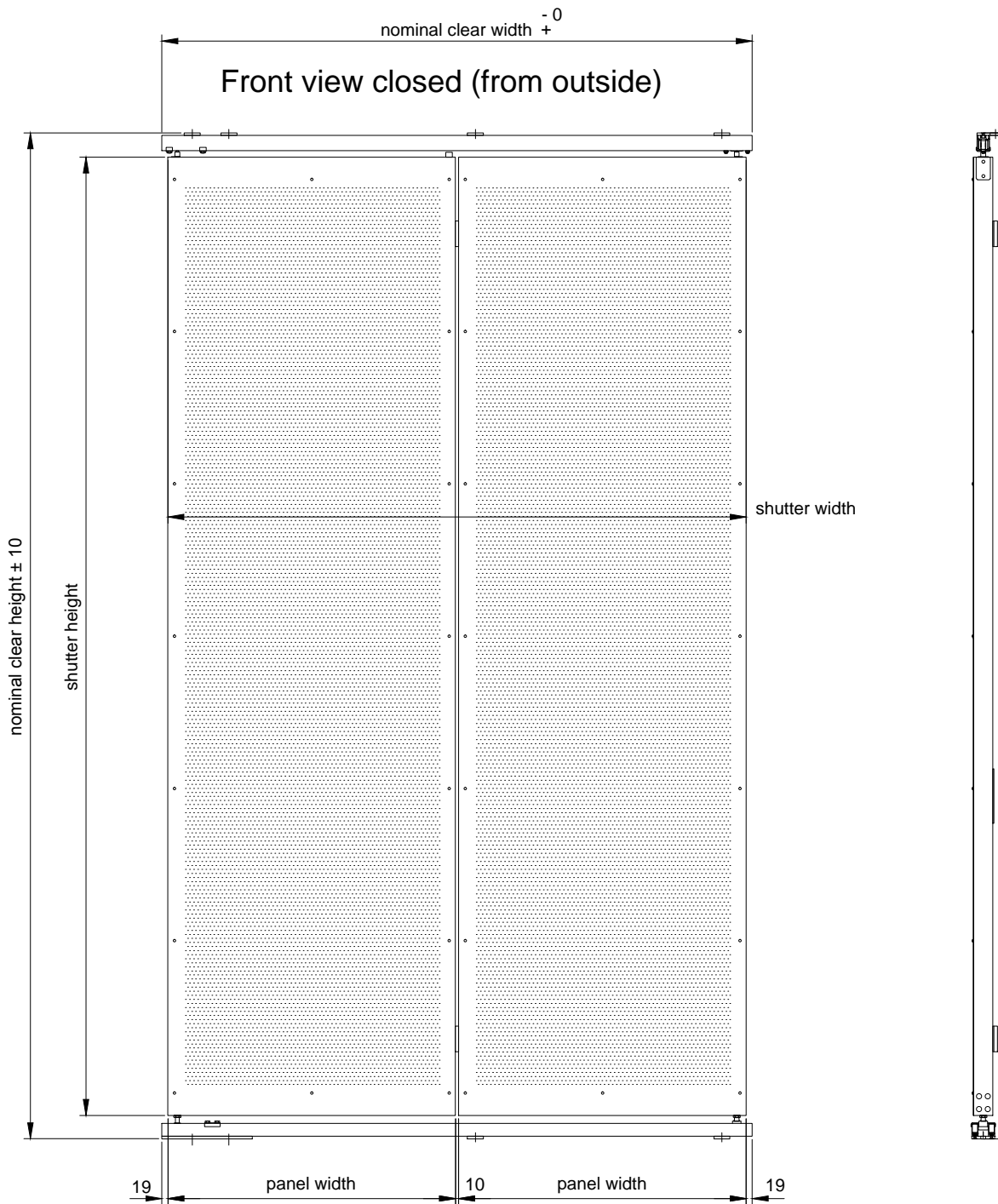

HunterDouglas

HUNTER DOUGLAS EUROPE B.V.

Architectural Projects

Window Coverings

Ceilings

Sun Control

Façades

Drwg.No.

SC-FS-SHEET-2D-07

Subject: Folding shutter / manual sheet view outside

Date:

11.11.2014

Size:

A4

Scale:

1:20

Rev:

00

Top view closed

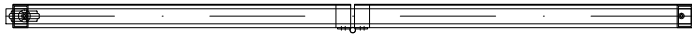

nominal clear width -0
+

Front view closed (from inside)

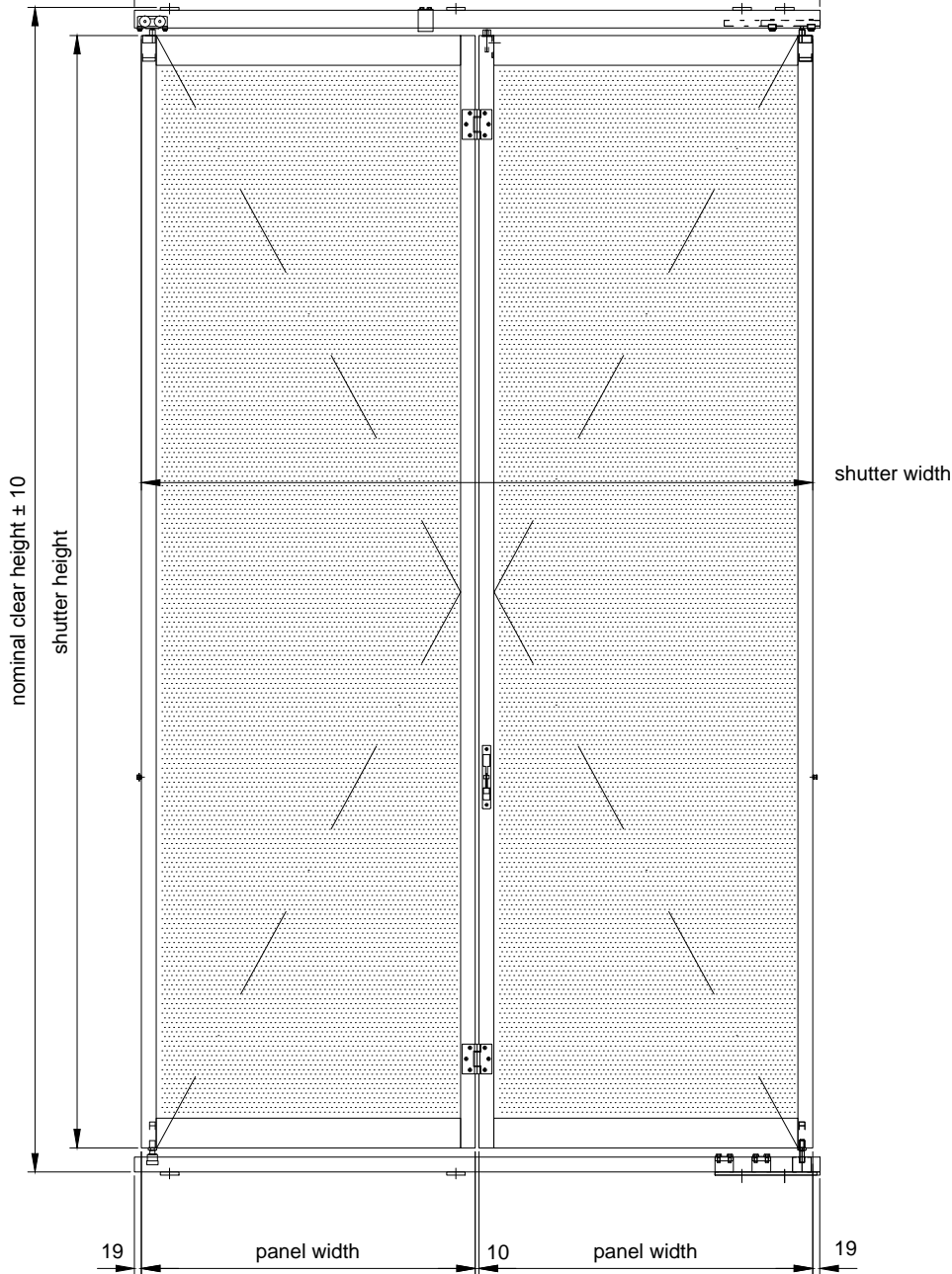

Section sheet

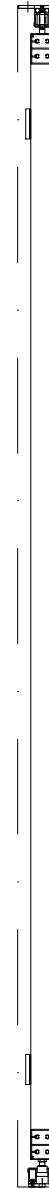

Section espanolette

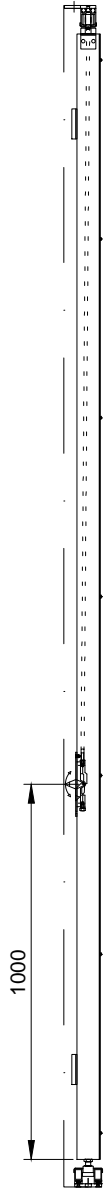

Top view bottom rail

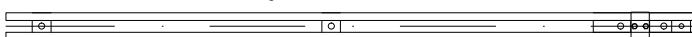

HunterDouglas

HUNTER DOUGLAS EUROPE B.V.

Architectural Projects

Window Coverings

Ceilings

Sun Control

Façades

Drwg.No.

SC-FS-SHEET-2D-08

Subject: Folding shutter / manual / sheet / closed

Date:

11.11.2014

Size:

A4

Scale:

1:20

Rev:

00

Top view
open 150

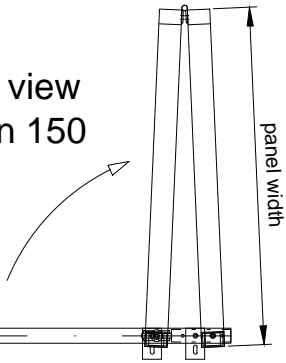

Top view
open 250

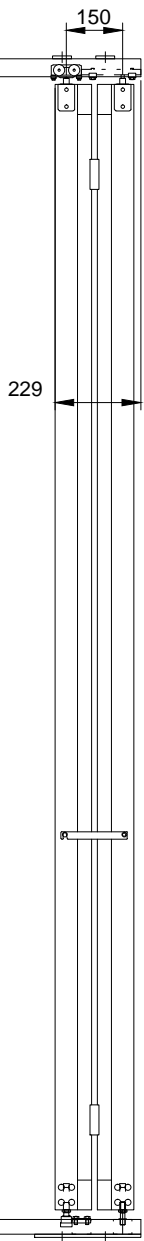
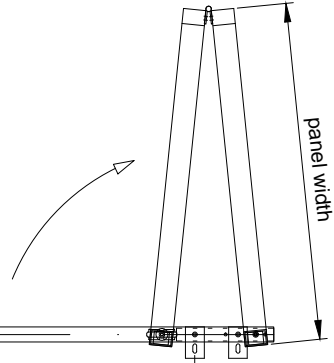

Front view open
(from inside)

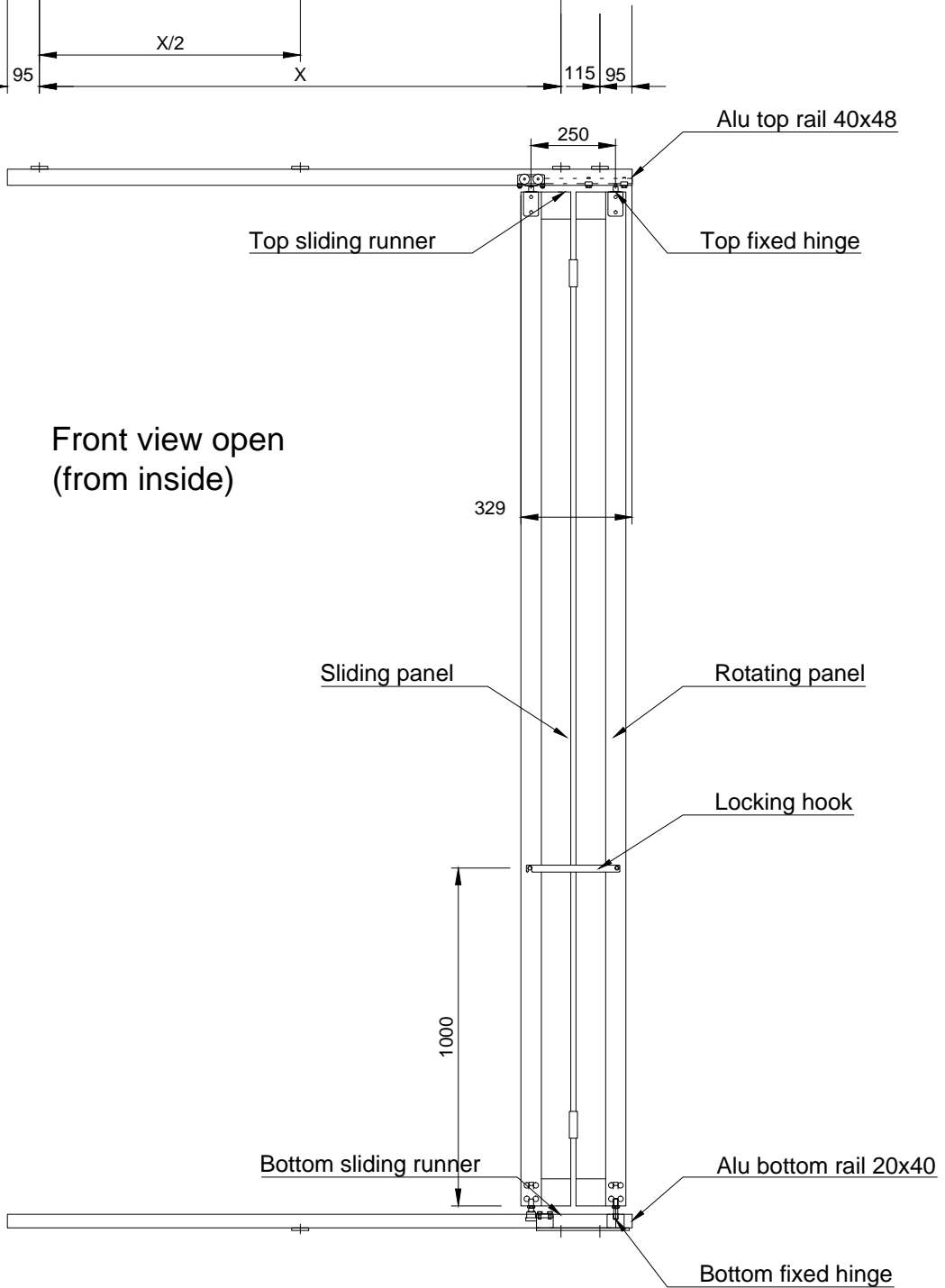

HunterDouglas

HUNTER DOUGLAS EUROPE B.V.

Architectural Projects

Window Coverings

Ceilings

Sun Control

Façades

Drwg.No.

SC-FS-SHEET-2D-09

Subject: Folding shutter / manual / open

Date:

11.11.2014

Size:

A4

Scale:

1:20

Rev:

00

Manual system

Front view closed (from outside)

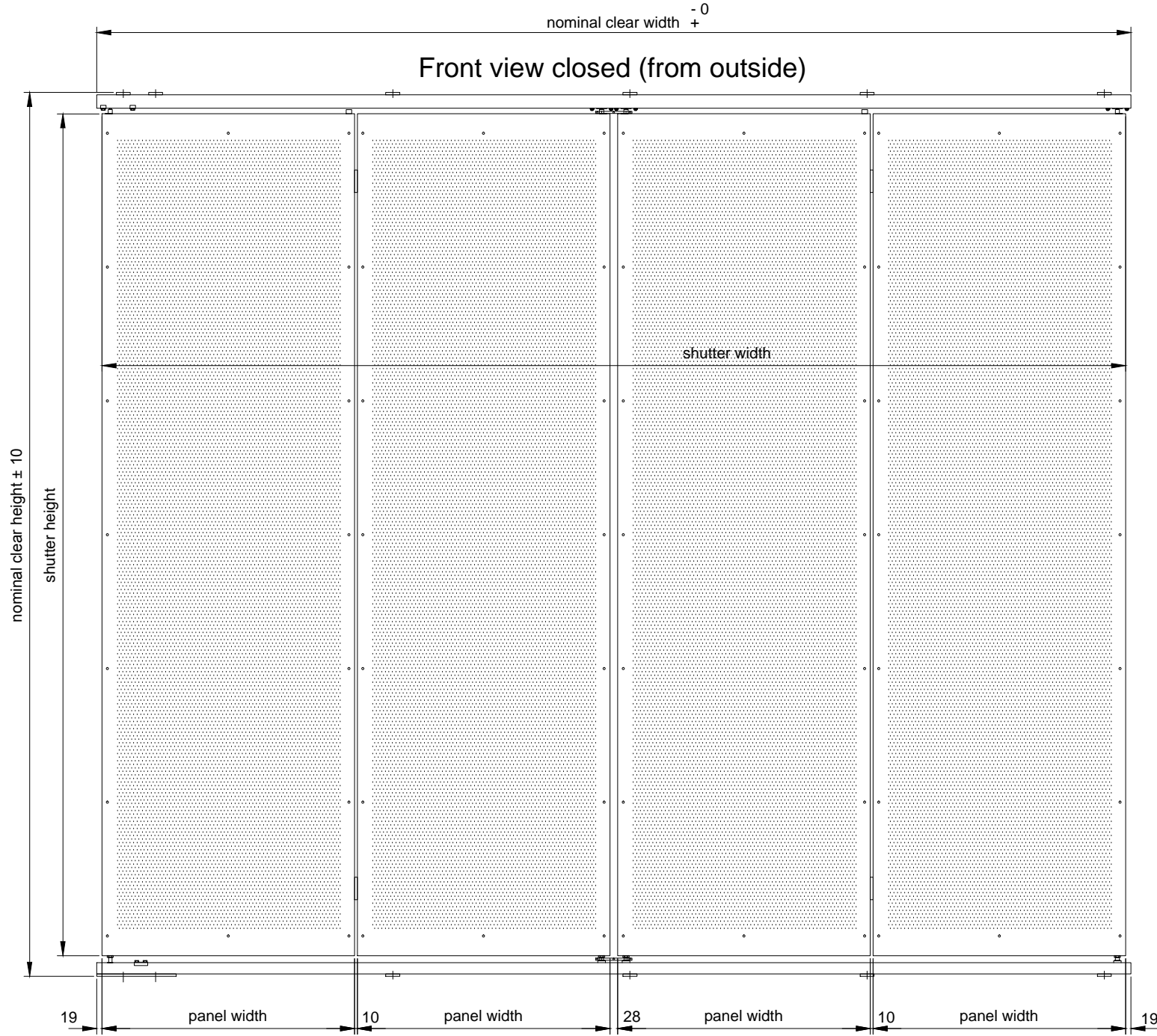

HunterDouglas

HUNTER DOUGLAS EUROPE B.V.

Architectural Projects

Window Coverings

Ceilings

Sun Control

Façades

Drwg.No.

SC-FS-SHEET-2D-10

Date: 11.11.2014

Scale: 1:10

Size: A4

Rev:

00

Subject: Folding shutter / manual W / outside

Top view open

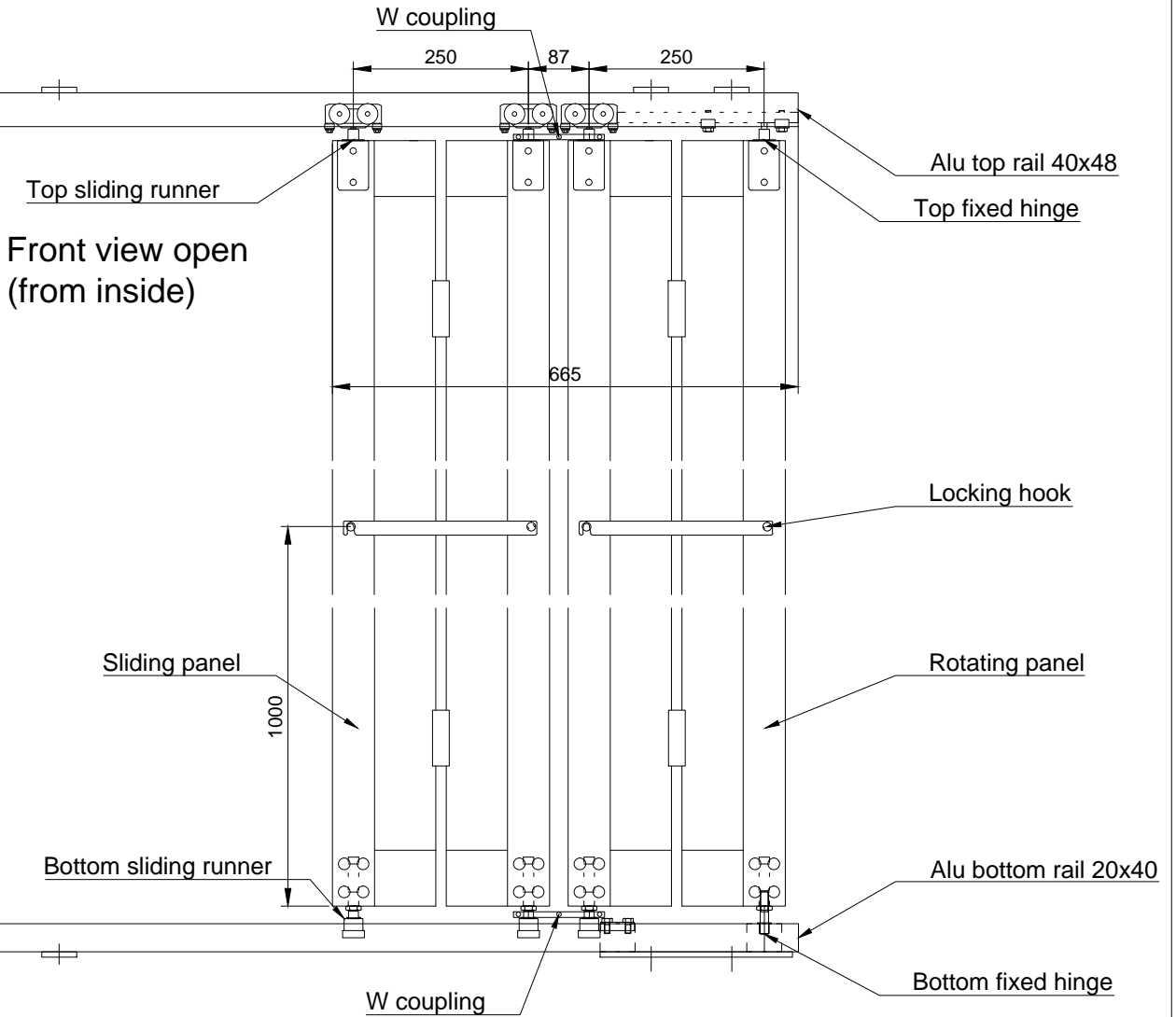
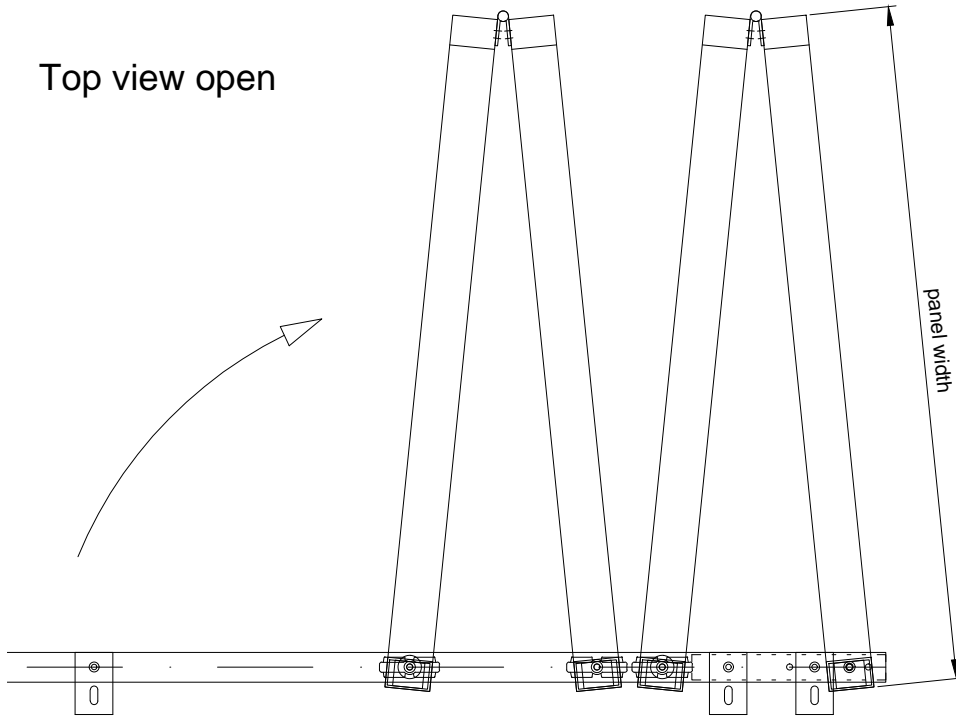

HunterDouglas

HUNTER DOUGLAS EUROPE B.V.

Architectural Projects

Window Coverings

Ceilings

Sun Control

Façades

Drwg.No.

SC-FS-SHEET-2D-11

Subject: Folding shutter / manual / W / open

Date:

11.11.2014

Size:

A4

Scale:

1:20

Rev:

00