

HunterDouglas
 SUN CONTROL SYSTEMS
 SUN CONTROL S-LOUVRES
 TYPE 84R SL5

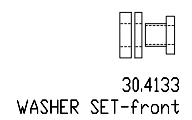

DRWG. No. SC-SL-84R-SL5-2D-01	SCALE: 1:2	REV. A	DATE: 28-10-2010	SIZE: A4
----------------------------------	---------------	-----------	---------------------	-------------

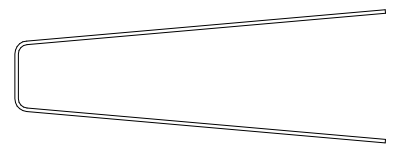
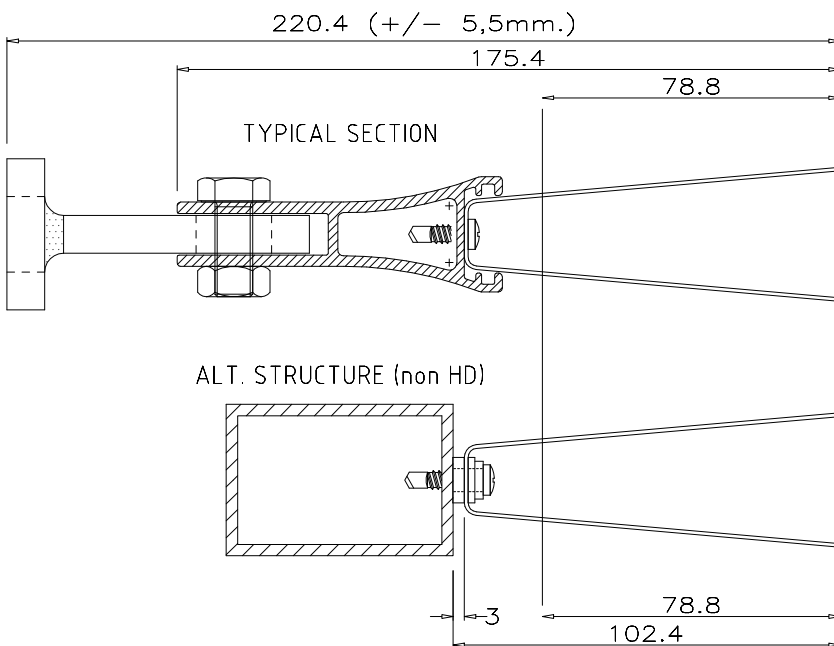
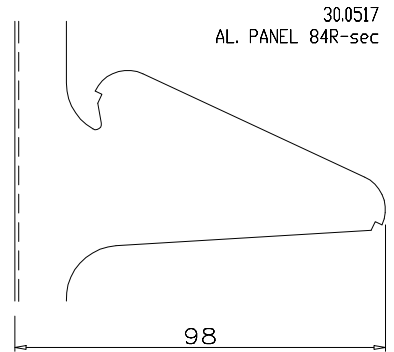
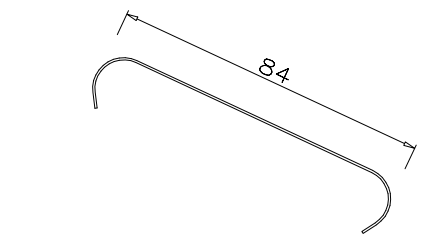
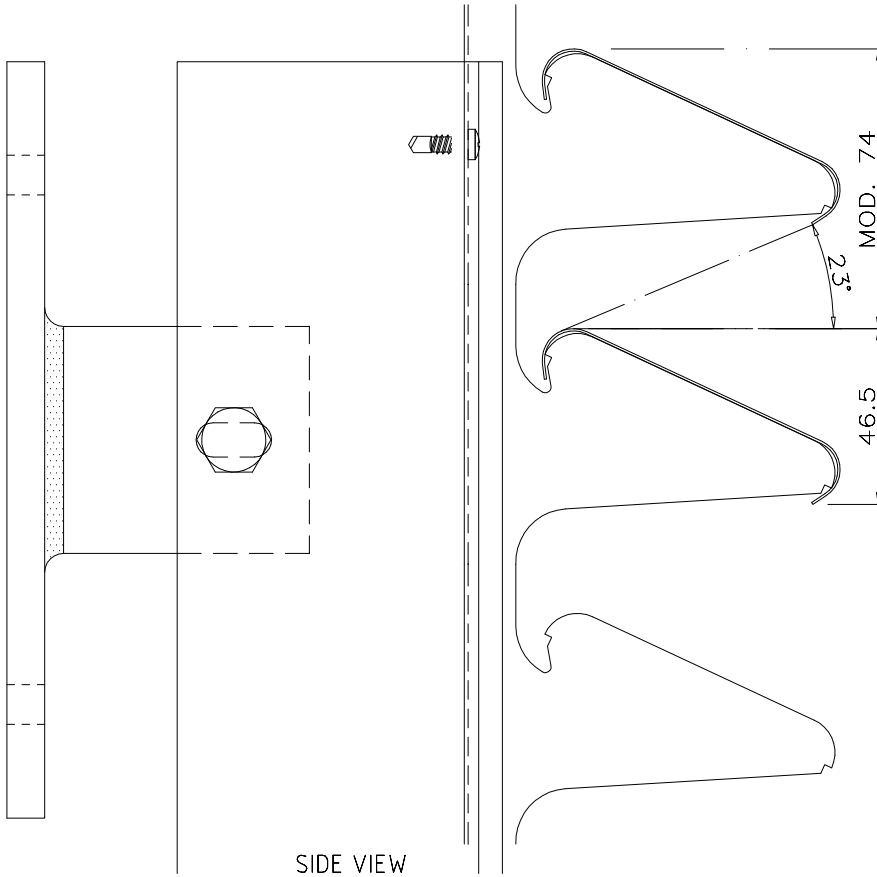
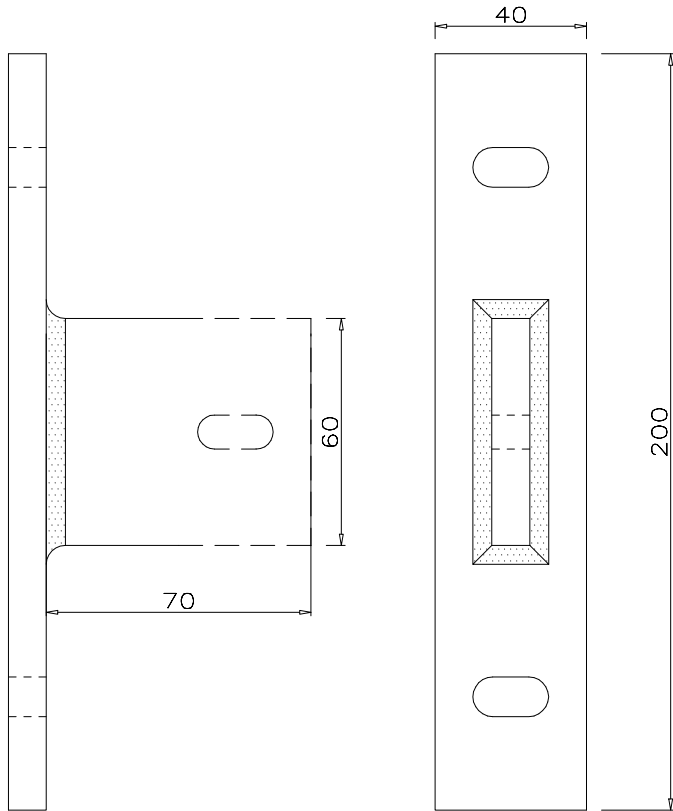

ACC. WALL BRACKET
 FOR SLR 60V-side

ACC. WALL BRACKET
 FOR SLR 60V&H-front

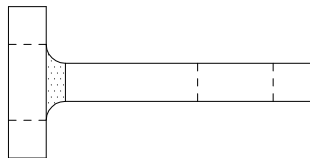

ACC. WALL BRACKET
 FOR SLR 60V-top

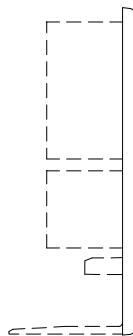

30.5060 SLR 60
 END CAP M-side

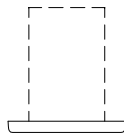

30.5060 SLR 60
 END CAP M-top

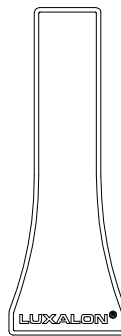

30.5060 SLR 60
 END CAP M-front

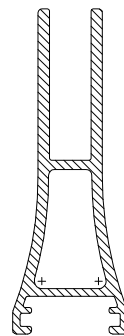

30.4604 SLR
 60V-sec

