

SIDE VIEW

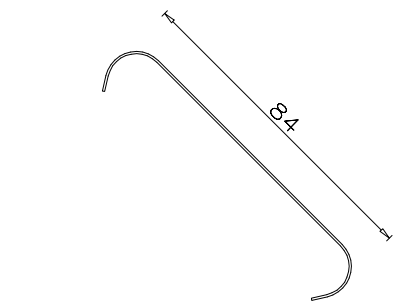

30.0517  
AL. PANEL 84R-sec

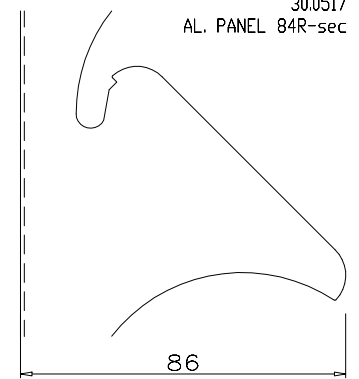

30.1444  
SL-STRINGER 4-side

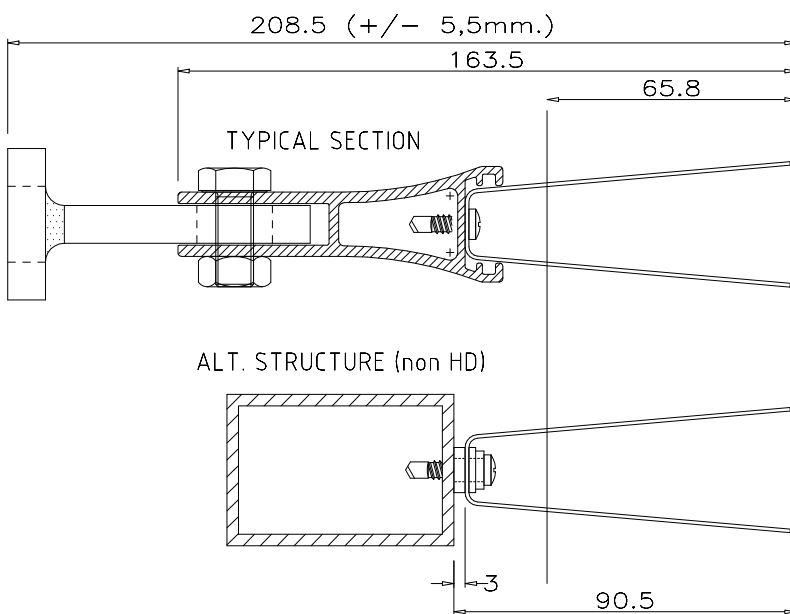

TYPICAL SECTION

ALT. STRUCTURE (non HD)

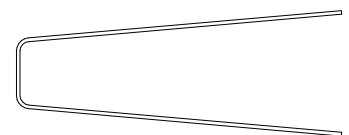

30.1444  
SL-STRINGER 4-side



30.4133  
WASHER SET-front

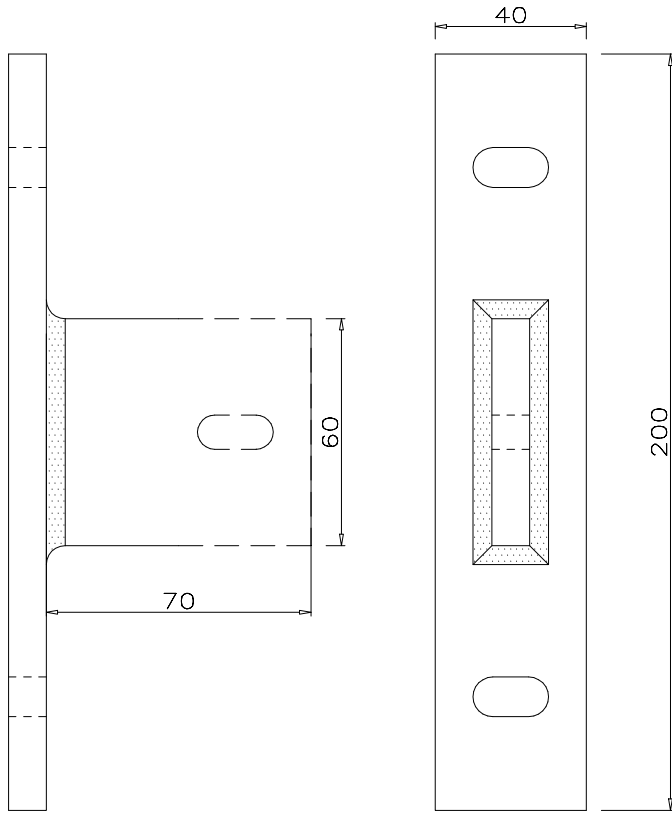

ACC. WALL BRACKET  
 FOR SLR 60V-side

ACC. WALL BRACKET  
 FOR SLR 60V&H-front

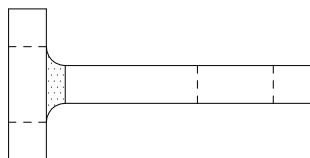

ACC. WALL BRACKET  
 FOR SLR 60V-top

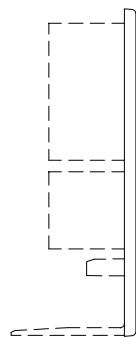

30.5060 SLR 60  
 END CAP M-side

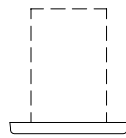

30.5060 SLR 60  
 END CAP M-top

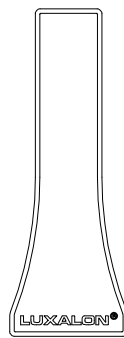

30.5060 SLR 60  
 END CAP M-front

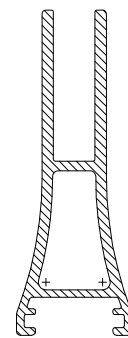

30.4604 SLR  
 60V-sec

