

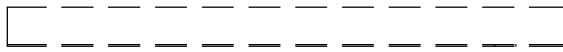

33.4505
AL PANEL SPLICE 84B-front



33.4505
AL PANEL SPLICE 84B-side



33.1226
AL PANEL 84B-sec



33.1226
AL PANEL 84B-side

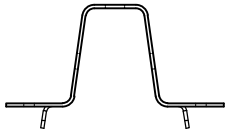

33.2531
AL CARRIER 84B-sec

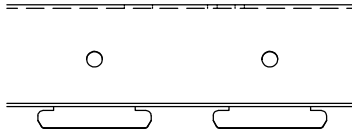

33.2531
AL CARRIER 84B-side

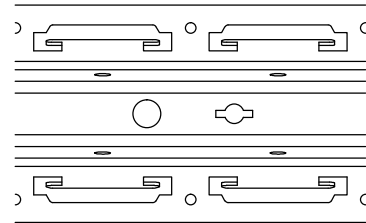

33.2531
AL CARRIER 84B-top

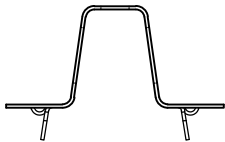

33.2009
AL CARRIER 84 RBC-sec

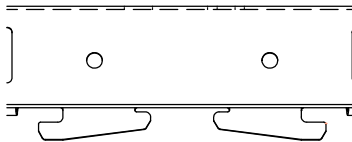

33.2009
AL CARRIER 84 RBC-side

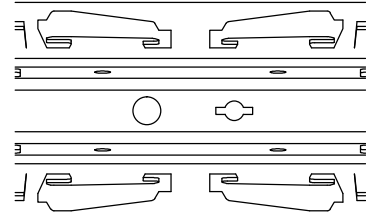

33.2009
AL CARRIER 84 RBC-top

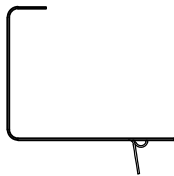

33.2494
Fe WALL CARRIER 84 RBC-sec

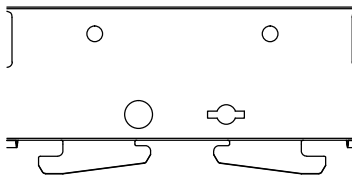

33.2494
Fe WALL CARRIER 84 RBC-side

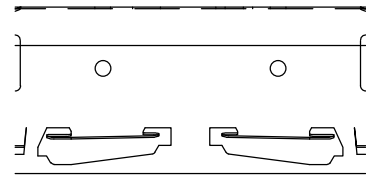

33.2494
Fe WALL CARRIER 84 RBC-top

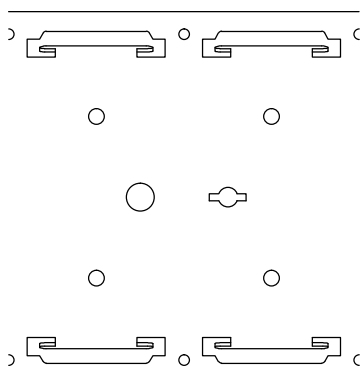

33.2996
AL FLEXIBLE CARRIER 84B-top



33.2996
AL FLEXIBLE CARRIER 84B-side



33.4490
AL PANEL CLIP 84B-front



33.2996
AL FLEXIBLE CARRIER 84B-sec



33.4490
AL PANEL CLIP 84B-side

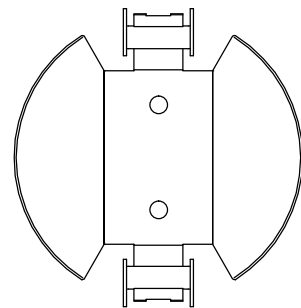

33.4490
AL PANEL CLIP 84B-top

HunterDouglas

HUNTER DOUGLAS EUROPE B.V.

Architectural Projects

Window Coverings

Ceilings

Sun Control

Façades

Drwg.No.

C-i-LI-84B-2D-01

Date:

01-04-2014

Scale:

1:2

Size:

A4

Rev:

1.0

Subject: Int. Linear Ceiling 84B



33.2410 EDGE PROFILE
AL-L 29x19-sec



33.5401 HOLD-DOWN
CLIP FOR AL-L-side



33.2428 EDGE PROFILE
0.8 AL-L 45x18.5-sec



33.5402 HOLD-DOWN CLIP
FOR L EDGE PROFILE-side

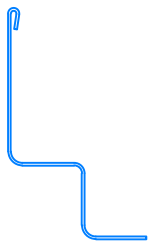

33.2424 EDGE PROFILE
0.8 AL-W 45x21x21x18.5-sec

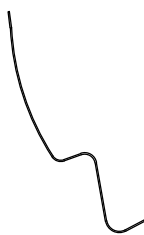

33.5403 HOLD-DOWN CLIP
FOR W EDGE PROFILE-side

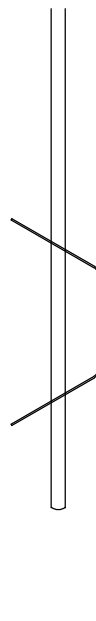

33.4795 SUSPENSION
ADJUST. SPRING-side
(see rod hanger ref.)

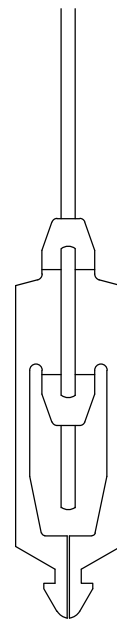

33.4795 SUSPENSION
ADJUST. SPRING-front
(see rod hanger ref.)



34.4180 LUXALON EDGE
COVER FIX PIECE - top



33.4626 AL DISTANCE
CLIP 84B-top

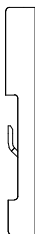

34.4180 LUXALON EDGE
COVER FIX PIECE - side

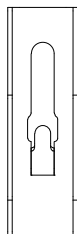

34.4180 LUXALON EDGE
COVER FIX PIECE - front



33.4626 AL DISTANCE
CLIP 84B-front



33.4626 AL DISTANCE
CLIP 84B-side

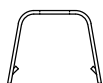

33.4173 CARRIER SPLICE
- front



33.4173 CARRIER SPLICE-side

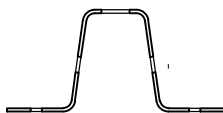

33.2147 UNPRONGED
AL CARRIER-sec

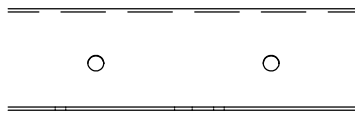

33.2147 UNPRONGED
AL CARRIER-side



33.2186 EDGE PROFILE
CLIP-DN 12.5mm-sec

HunterDouglas

HUNTER DOUGLAS EUROPE B.V.

Architectural Projects

Drwg.No.

C-i-LI-84B-2D-02

Date:

01-04-2014

Scale:

1:2

Size:

A4

Rev:

1.0

Subject: Int. Linear Ceiling 80B

Window Coverings

Ceilings

Sun Control

Façades