

* -

HunterDouglas 
Architectural

Drwg.No. C-i-Me-PI-Gamma -Lay-on -2D_Application A	Date: 19.07.2019	Scale: 1:5
	Size: A3	Rev: -
Subject: Ceiling Interior Metal Planks Gamma Lay-on		

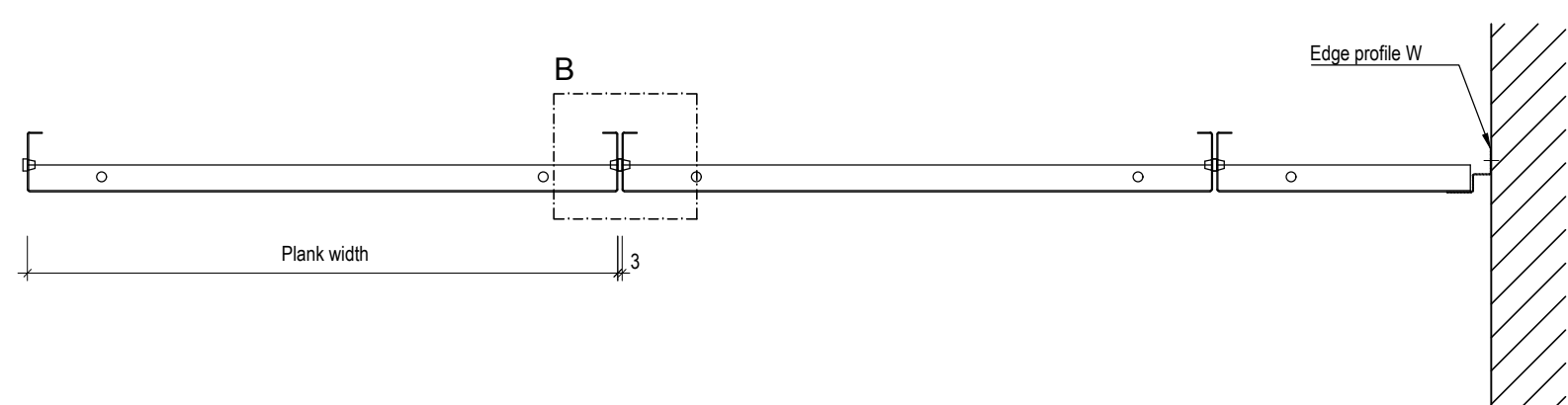
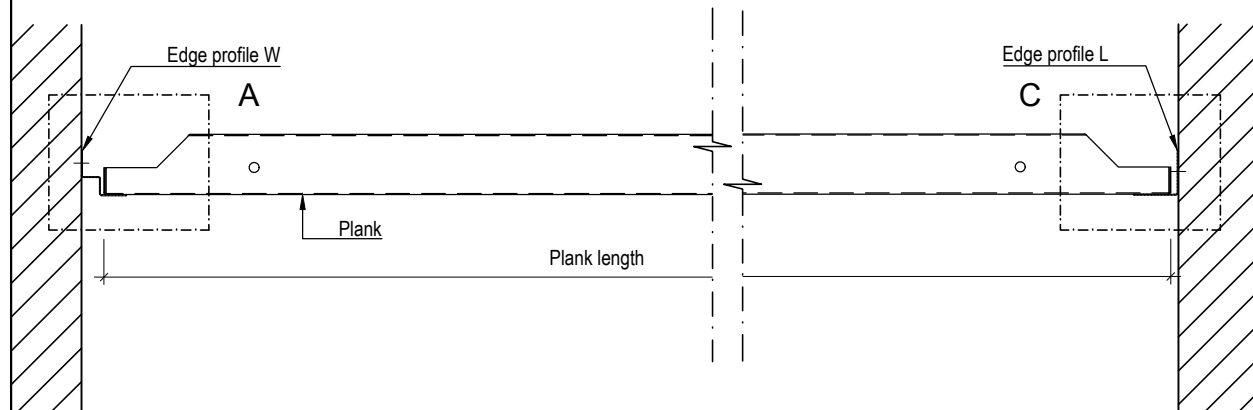
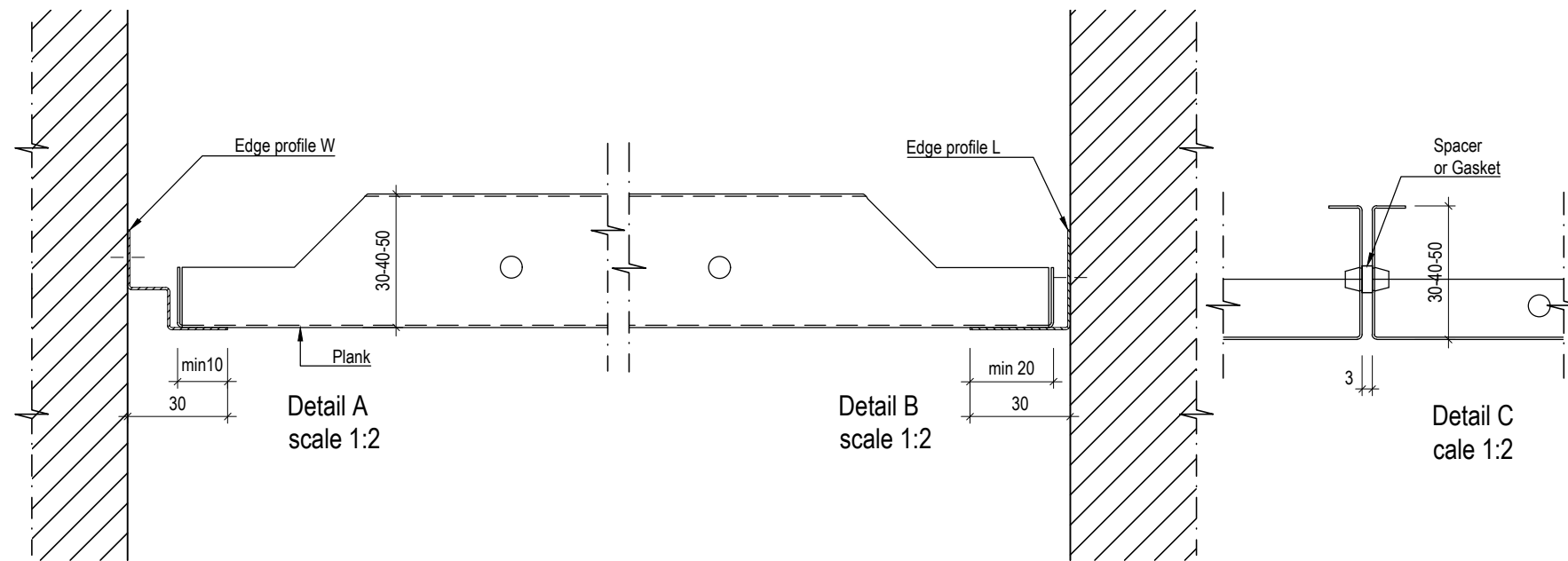
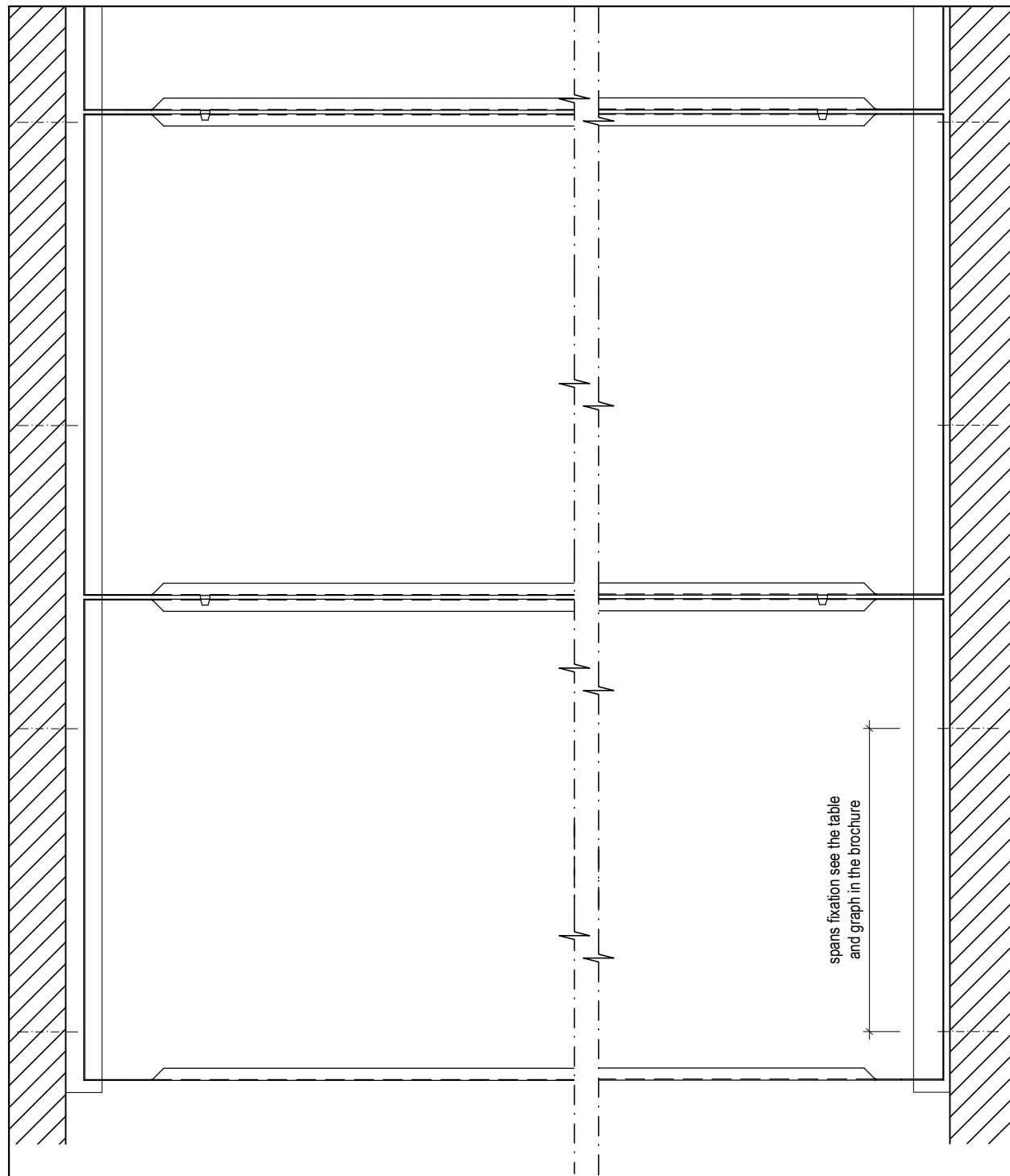

* -

HunterDouglas 
Architectural

Drwg.No. C-i-Me-PI-Gamma -Lay-on -2D_Application B	Date: 19.07.2019	Scale: 1:5
	Size: A3	Rev: -
Subject: Ceiling Interior Metal Planks Gamma Lay-on		

**Plank Gamma Lay-on
Height 50 mm Al / Fe**

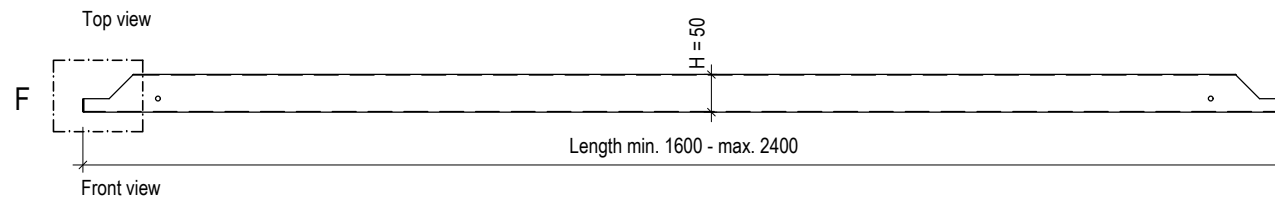
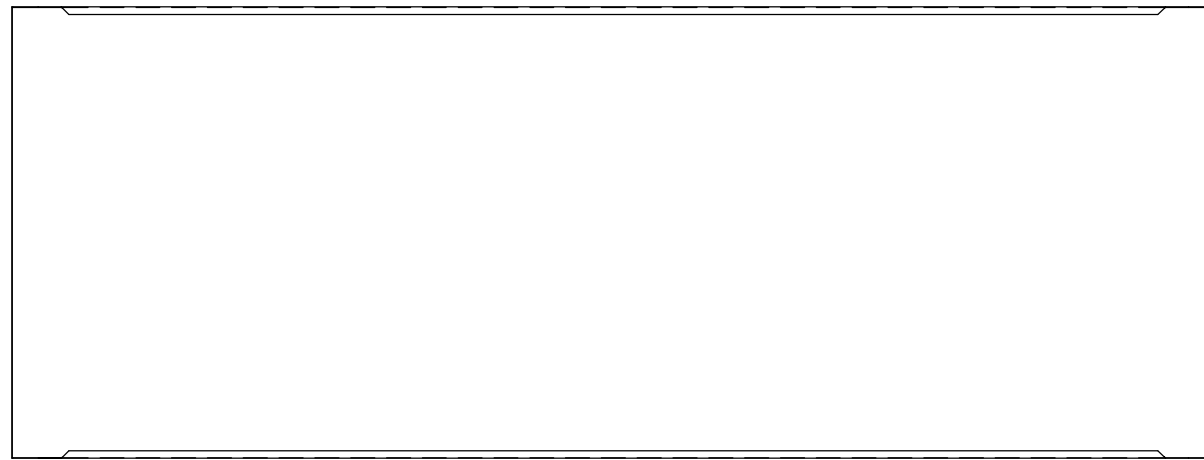
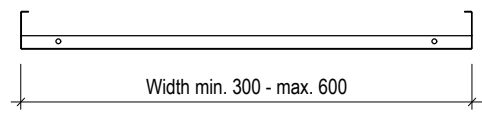

**Plank Gamma Lay-on
Height 40 mm Al / Fe**

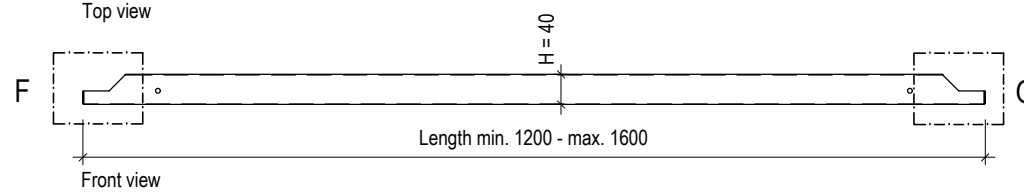
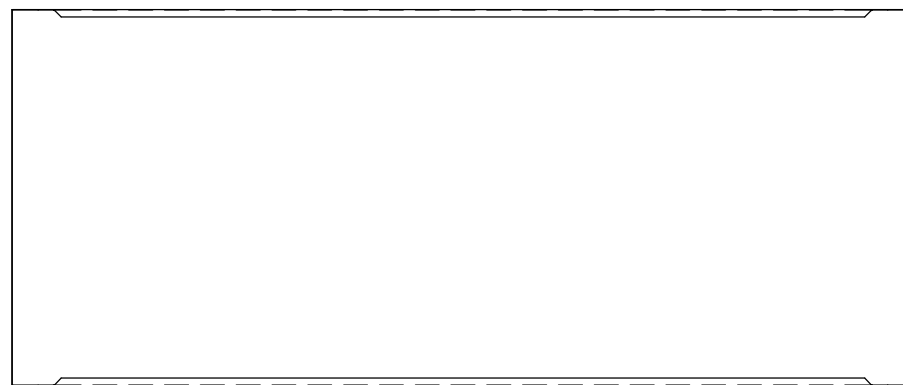
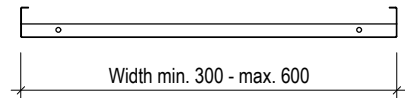

**Plank Gamma Lay-on
Height 30 mm Al / Fe**

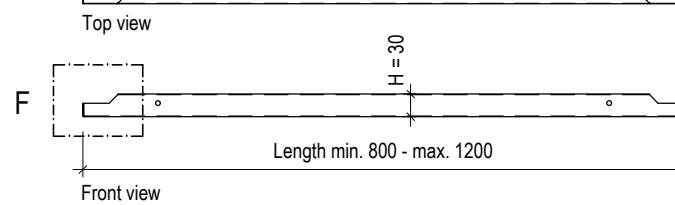
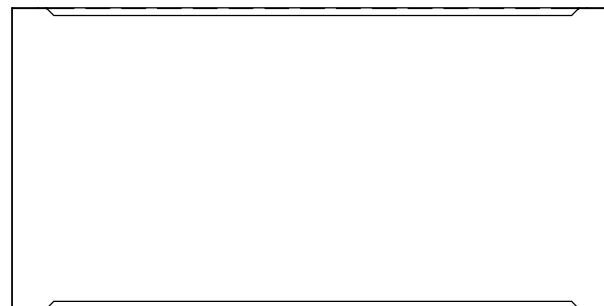
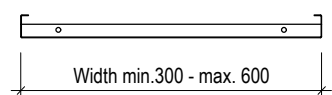

PERFORATION PATTERNS scale 1:1

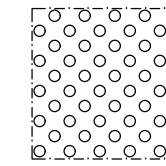

D1522
φ 1,5 mm
↑ 4 mm ↔ 4 mm
Openness 22 %

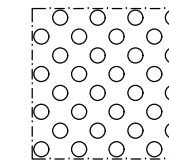

D2022
φ 2 mm
↑ 5 mm ↔ 5 mm
Openness 22 %

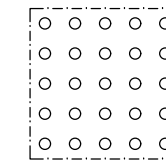

D1511
φ 1,5 mm
↑ 4 mm ↔ 4 mm
Openness 11 %

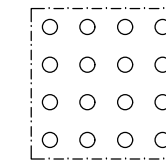

D2011
φ 2 mm
↑ 5 mm ↔ 5 mm
Openness 11 %

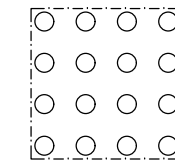

D2516
φ 2,5 mm
↑ 5,5 mm ↔ 5,5 mm
Openness 16 %

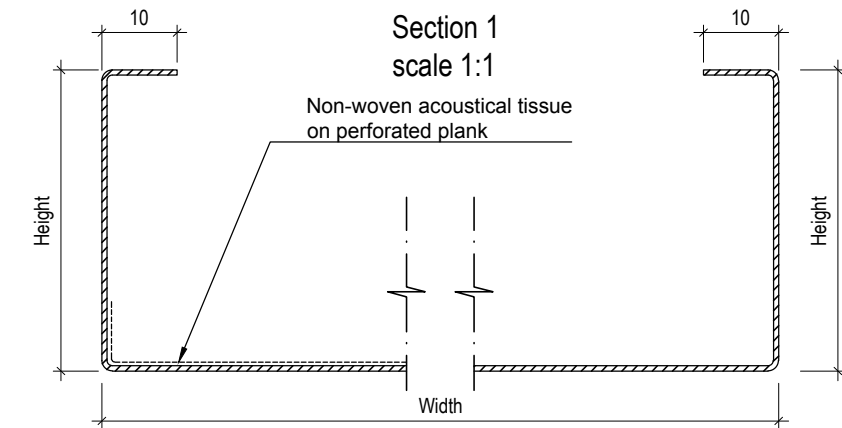

Width from	to	Length from	to	Height
300	600	800	1200	30
300	600	1200	1600	40
300	600	1600	2400	50

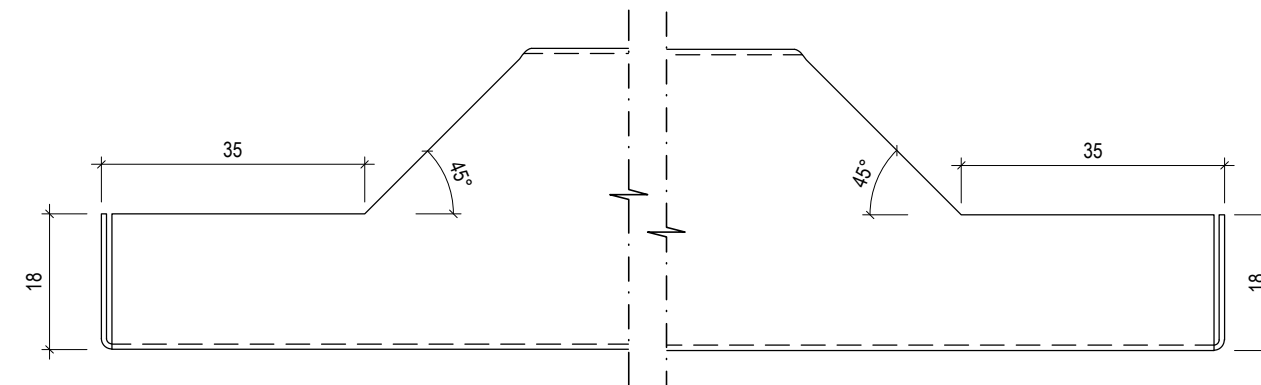

**GAMMA BANDRASTER
(Non Hunter Douglas)**

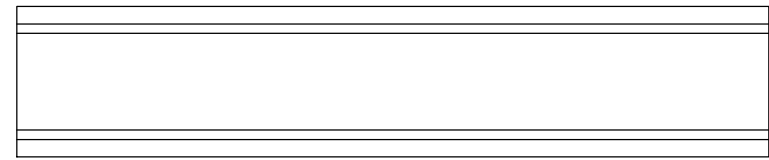

Top view

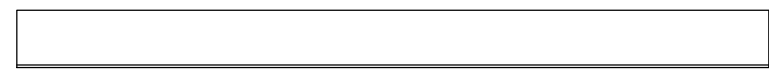

Front view max 4000

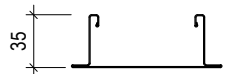

Side-view
50-75-100-125-150

**GAMMA BANDRASTER SPLICE
(Non Hunter Douglas)**

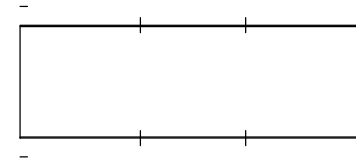

Top view



Front view 230



Side-view
50-75-100-125-150

**UPPER NONIUS HANGER
Length: 150, 300, 500, 1000, 1500, 2000mm**

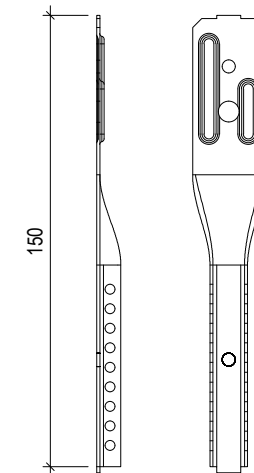

Side view 150
Front view 13

LOWER NONIUS HANGER

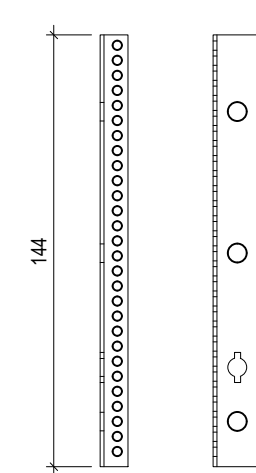

Side view 144
Front view 16

**GAMMA BRACKET 50 - 75 - 100 - 125 - 150
(Non Hunter Douglas)**



Top view 50



Top view 75



Top view 100



Top view 125



Top view 150

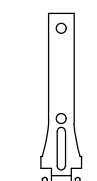

Front view 50
27
50

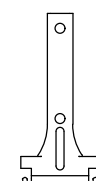

Front view 75
52
75

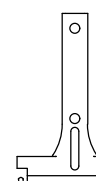

Front view 100
77
100

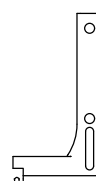

Front view 125
102
125

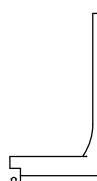

Front view 150
127
150

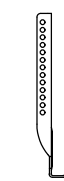

Side-view

EDGE-PROFILE Al / Fe

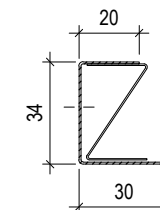

EDGE-PROFILE U 30
L= max.3000 mm

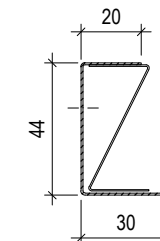

EDGE-PROFILE U 40
L= max.3000 mm

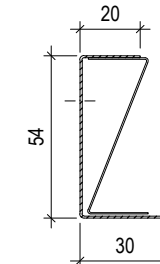

EDGE-PROFILE U 50
L= max.3000 mm

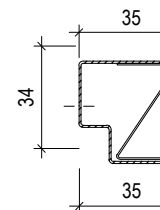

EDGE-PROFILE UW 30
L= max.3000 mm

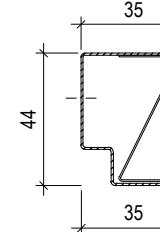

EDGE-PROFILE UW 40
L= max.3000 mm

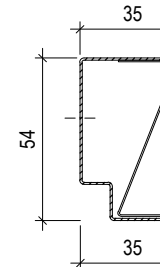

EDGE-PROFILE UW 50
L= max.3000 mm

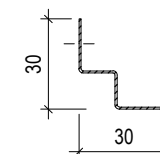

EDGE-PROFILE W 30
L= max.3000 mm

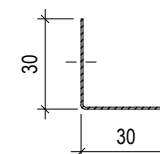

EDGE-PROFILE L 30
L= max.3000 mm



LOCKING-PROFILE 30
L= max.1160 mm



LOCKING-PROFILE 40
L= max.1160 mm



LOCKING-PROFILE 50
L= max.1160 mm

SPACER 3 mm

