

* -

HunterDouglas 
Architectural

Drwg.No. C-i-Me-PI-Beta -Hook-on Singular -2D_Application A	Date: 19.07.2019	Scale: 1:5
	Size: A3	Rev: -
Subject: Ceiling Interior Metal Planks Beta Hook on Singular		

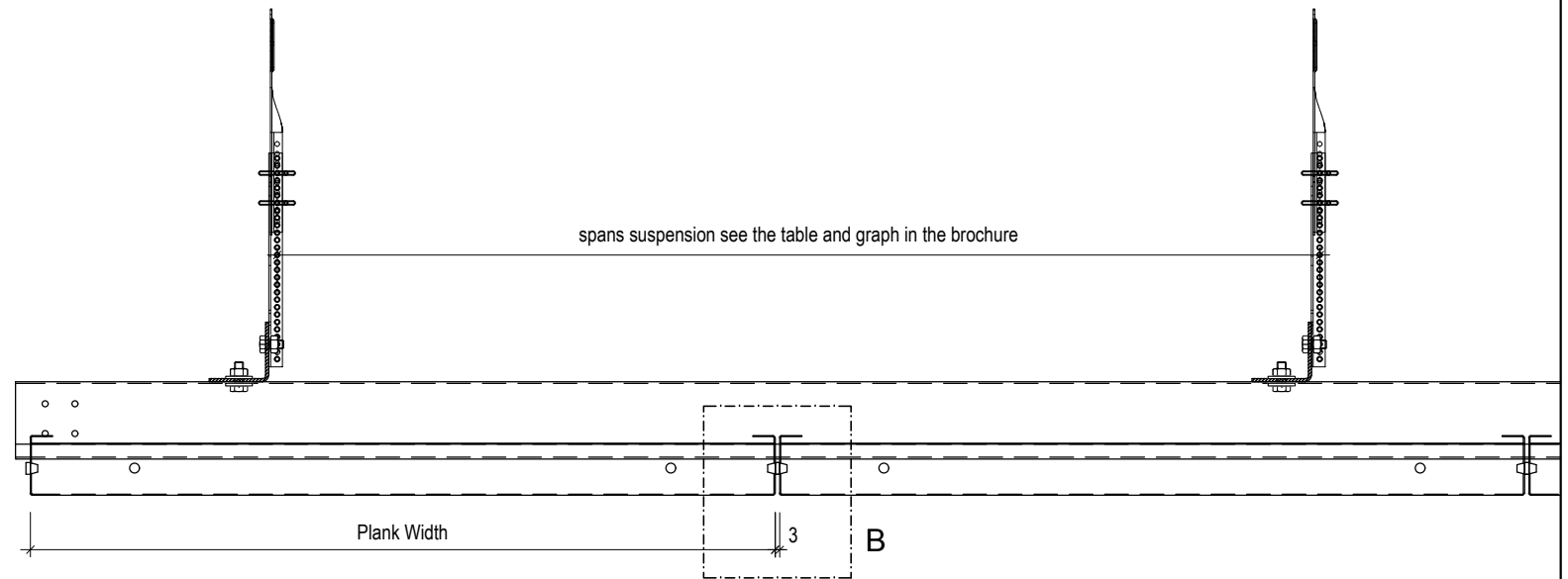
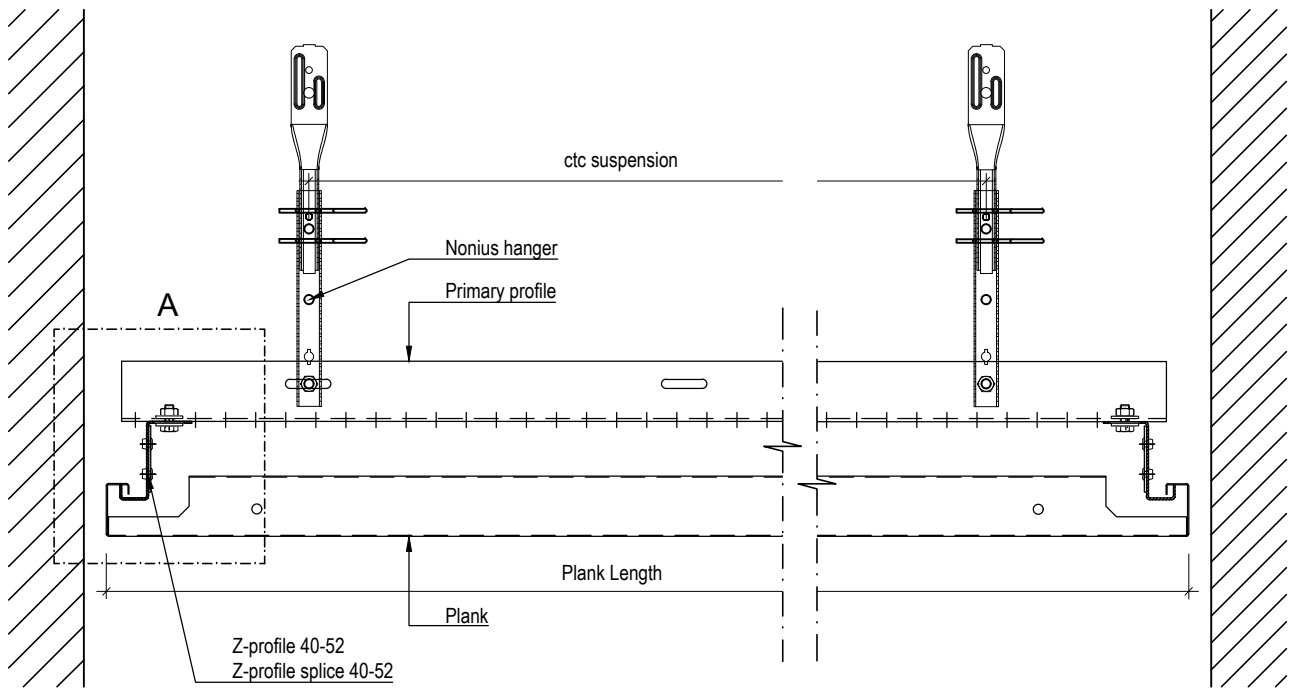
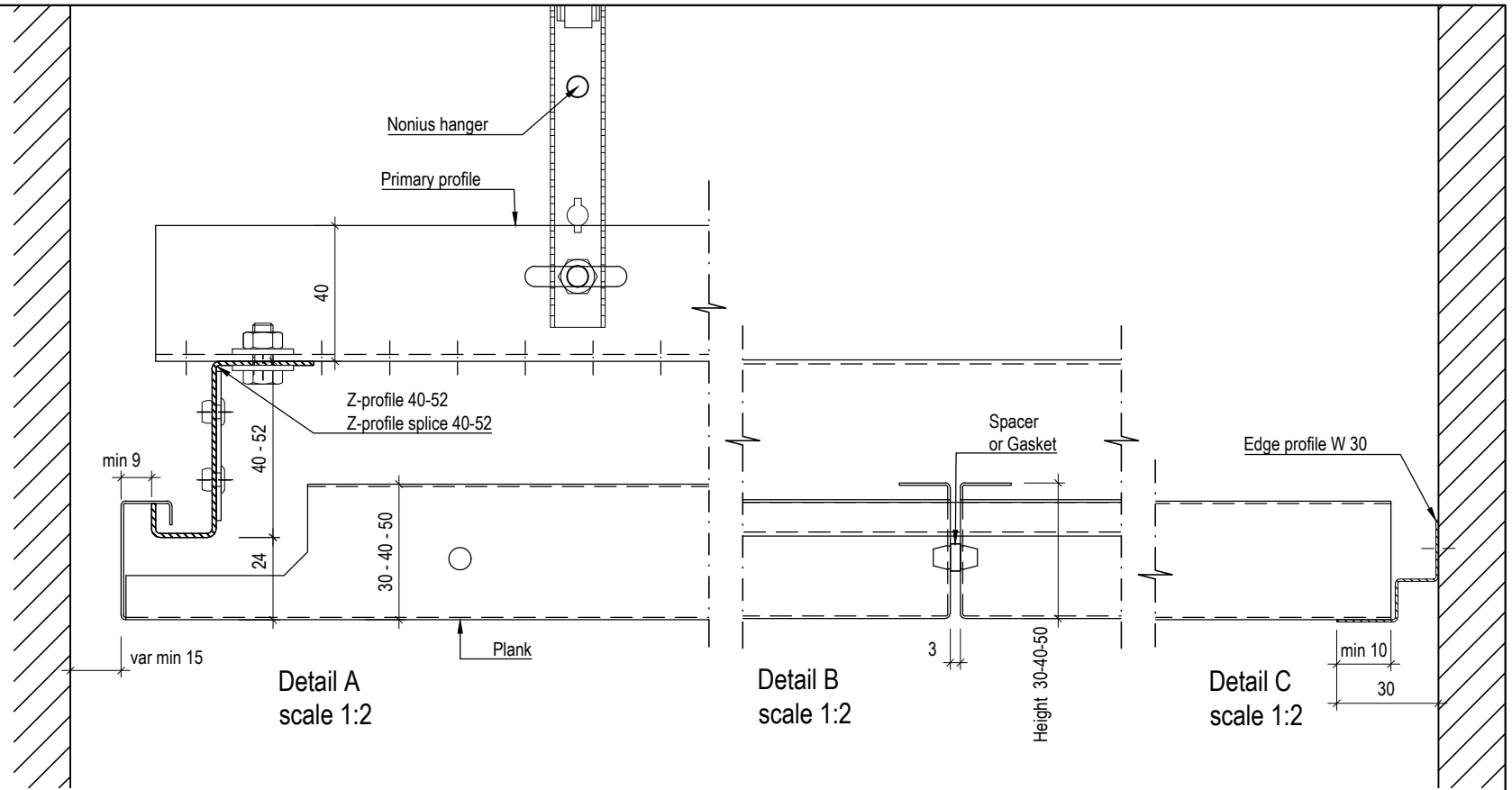
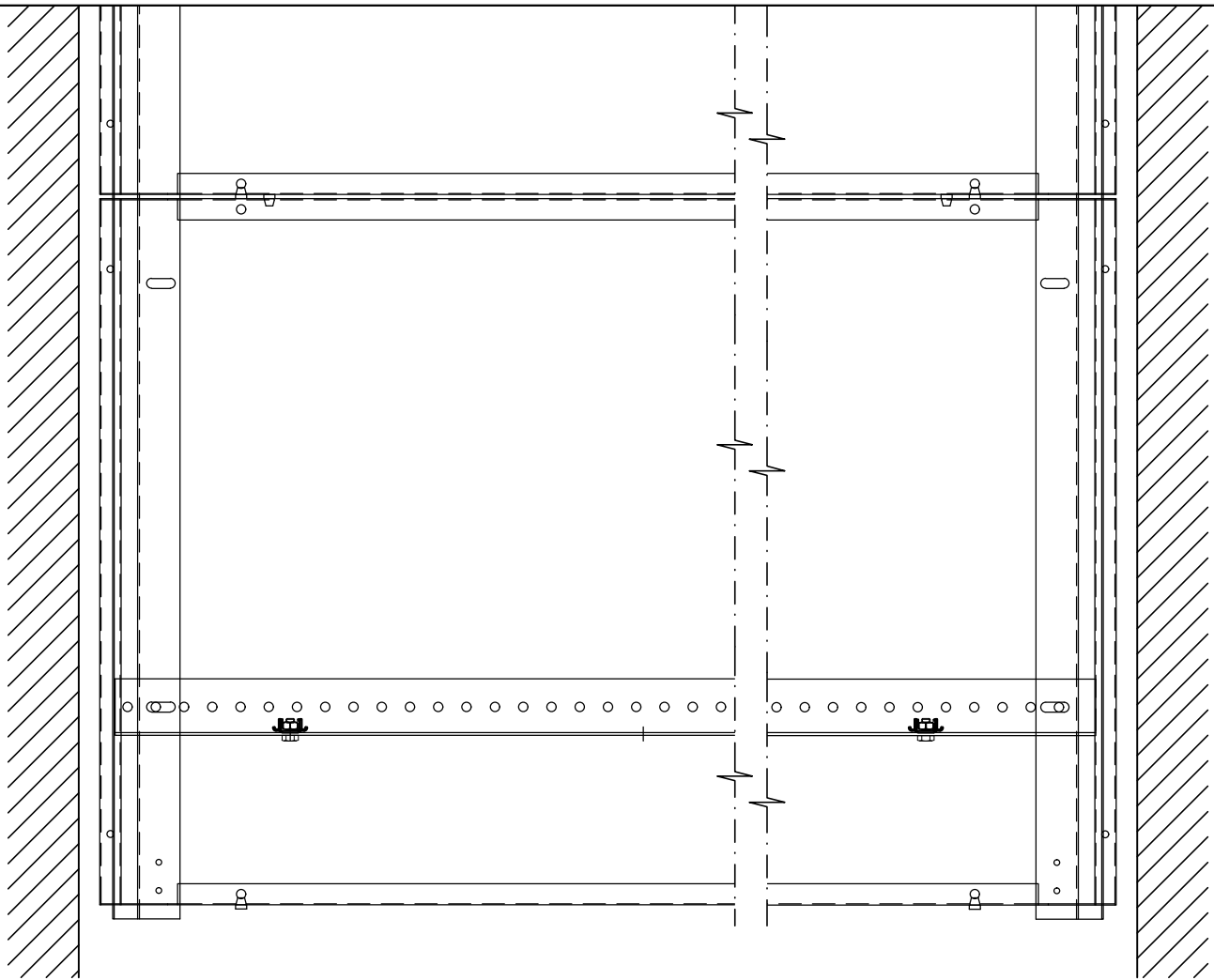

* -

HunterDouglas 
Architectural

Drwg.No. C-i-Me-PI-Beta -Hook-on Singular -2D_Application B	Date: 19.07.2019	Scale: 1:5
	Size: A3	Rev: -
Subject: Ceiling Interior Metal Planks Beta Hook on Singular		

**Plank Beta Hook-on Singular
Height 50 mm Al / Fe**

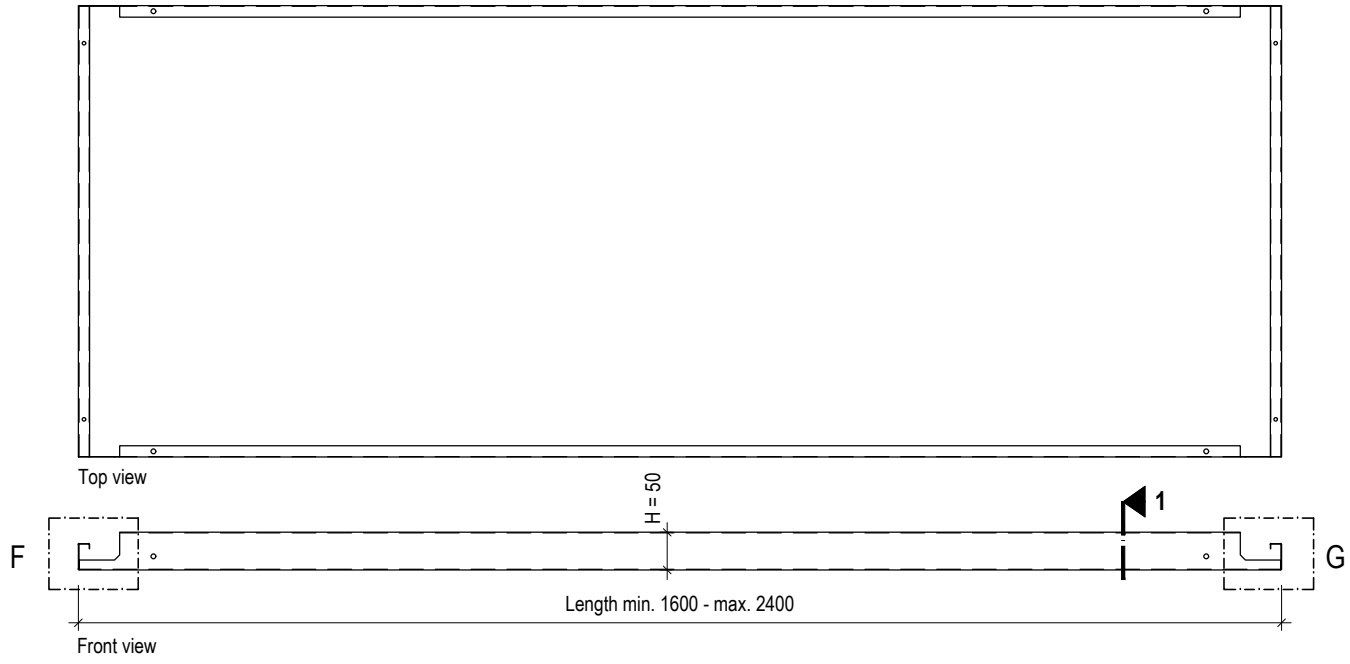
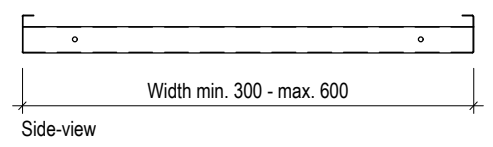

**Plank Beta Hook-on Singular
Height 40 mm Al / Fe**

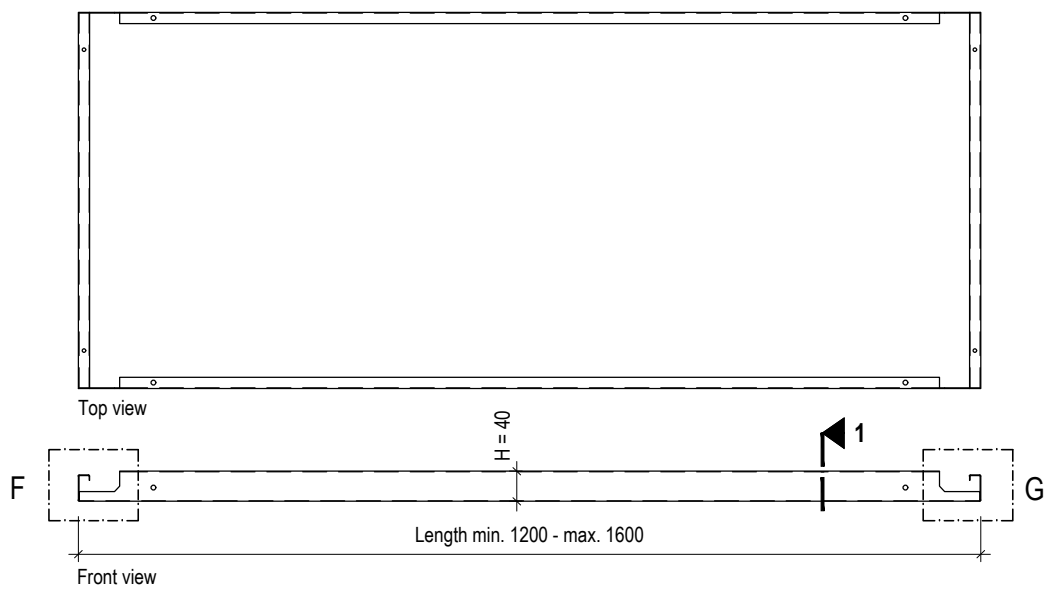
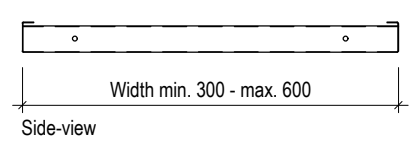

**Plank Beta Hook-on Singular
Height 30 mm Al / Fe**

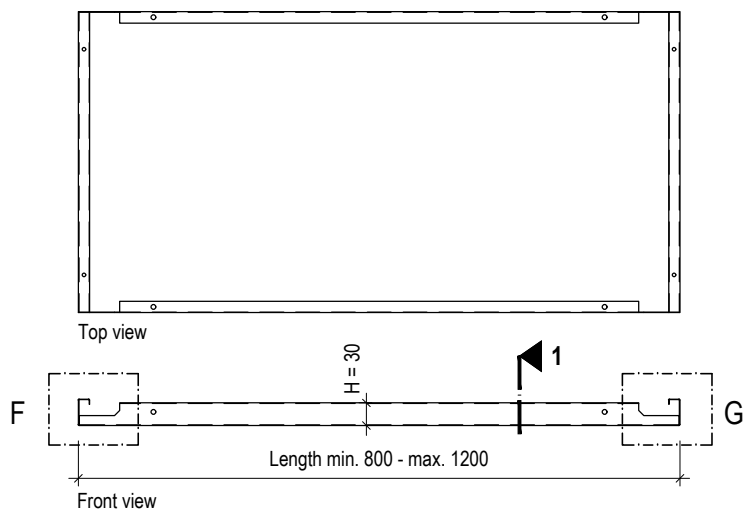
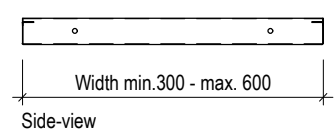

PERFORATION PATTERNS scale 1:1

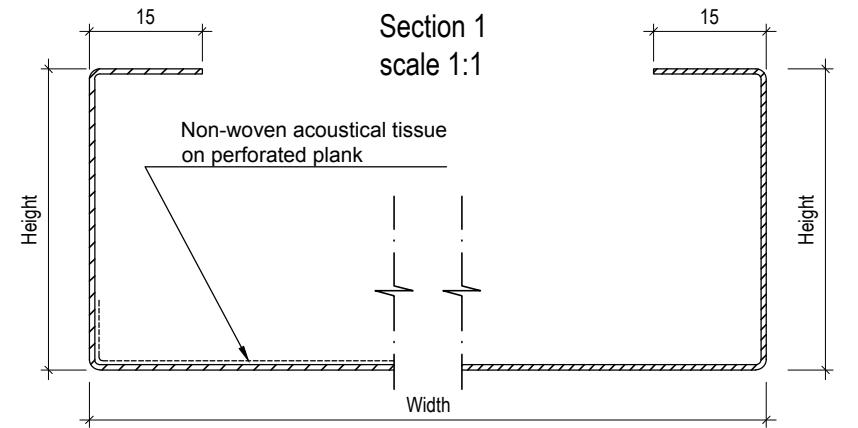
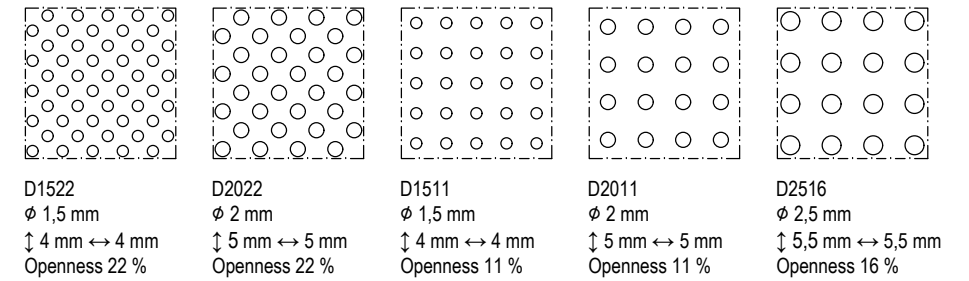

Width from	Width to	Length from	Length to	Height
300	600	800	1200	30
300	600	1200	1600	40
300	600	1600	2400	50
600	1000	800	2000	50
300	500	800	3000	50

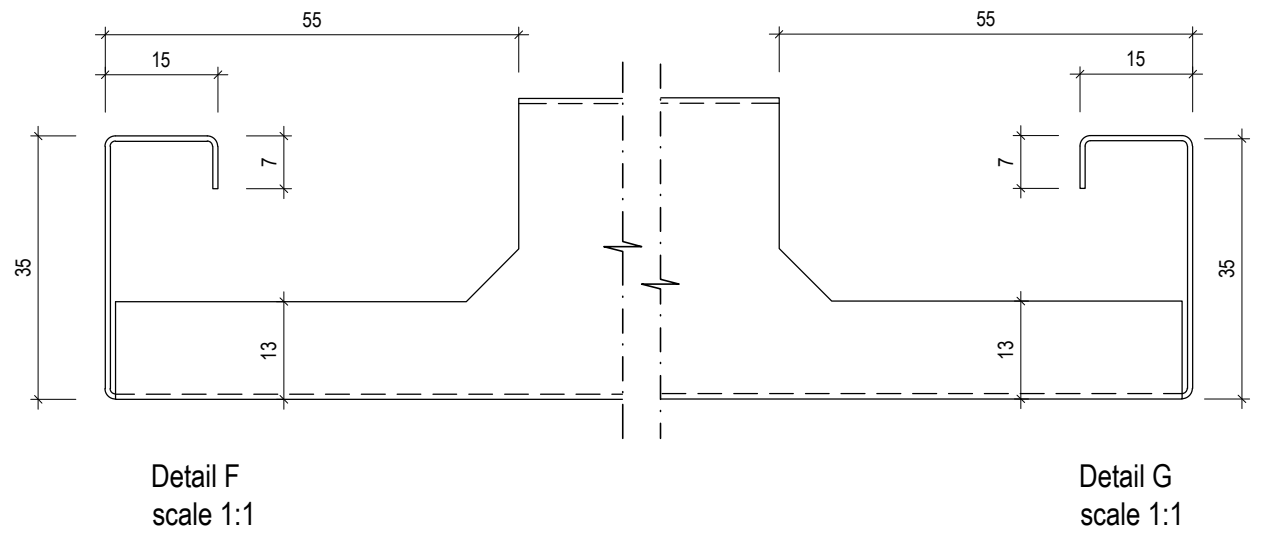

Drwg.No. C-i-Me-PI-Beta -Hook-on Singular -2D_Planks	Date: 19.07.2019	Scale: 1:10
	Size: A3	Rev: -
Subject: Ceiling Interior Metal Planks Beta Hook on Singular		

Z-PROFILE 52 Fe

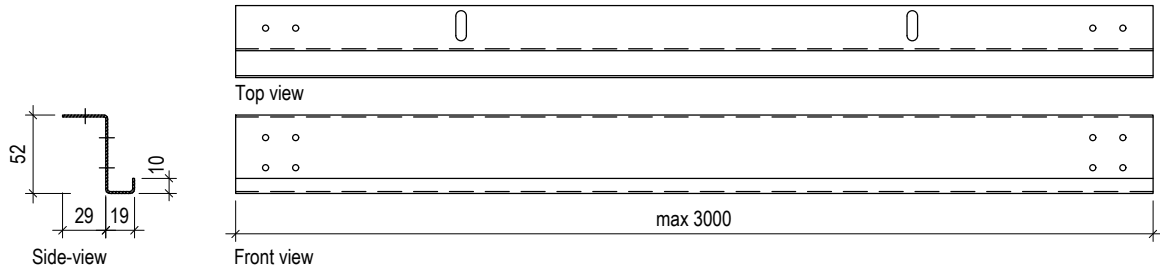

Z-PROFILE 40 Fe

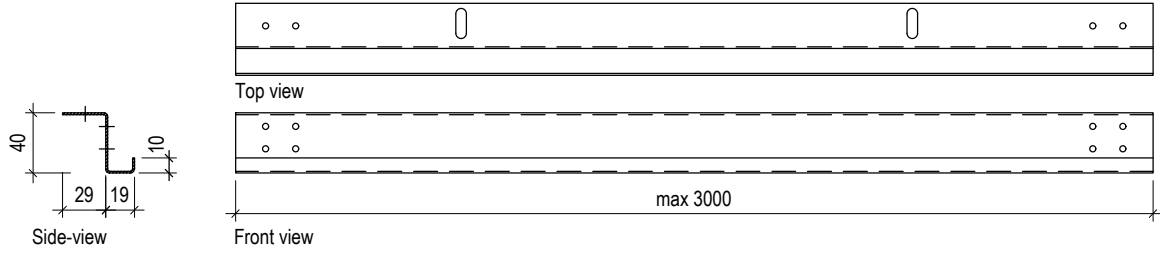

PRIMARY PROFILE Fe

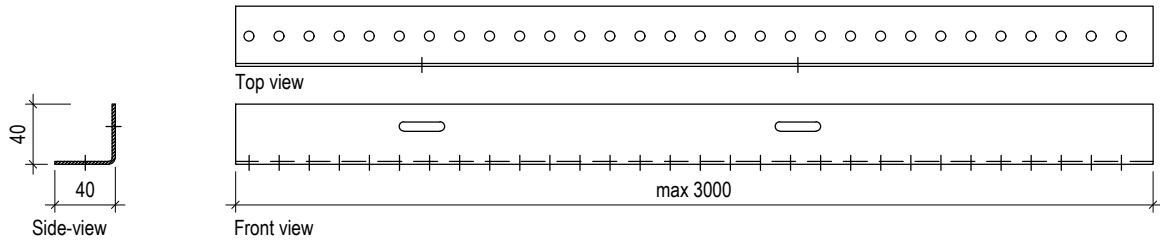

CORRIDOR PROFILE Fe

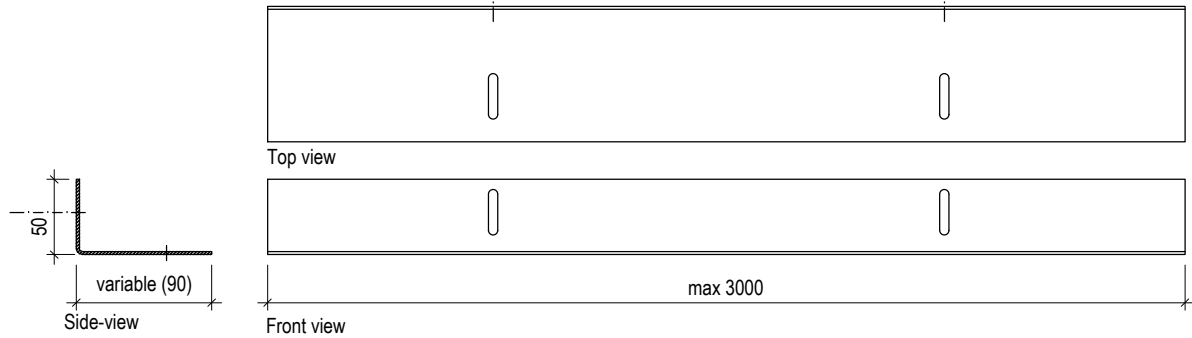

Z-PROFILE SPLICE 52

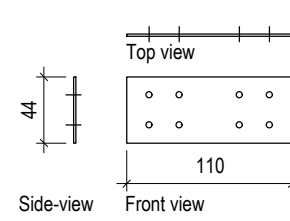

Z-PROFILE SPLICE 40

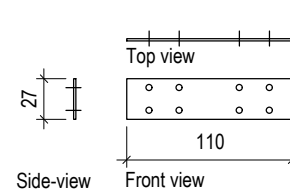

SPACER 3 mm

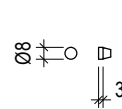

UPPER NONIUS HANGER
Length: 150, 300, 500, 1000, 1500, 2000mm

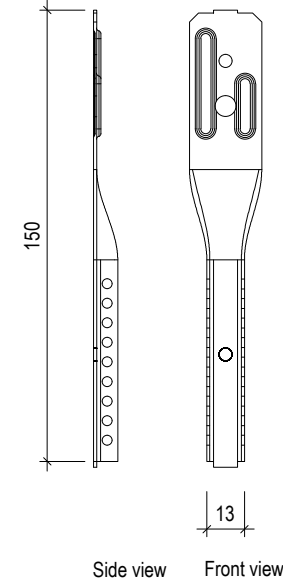

LOWER NONIUS HANGER

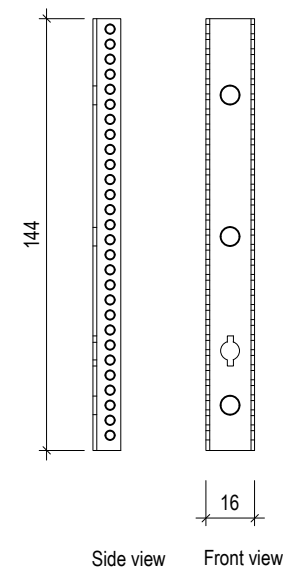

EDGE-PROFILE Al / Fe

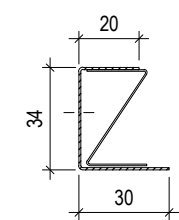

EDGE-PROFILE U 30
L= max.3000 mm

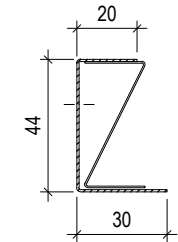

EDGE-PROFILE U 40
L= max.3000 mm

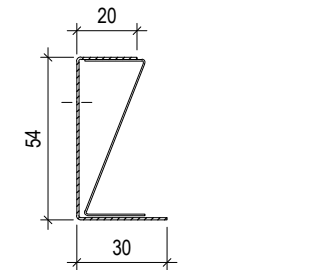

EDGE-PROFILE U 50
L= max.3000 mm

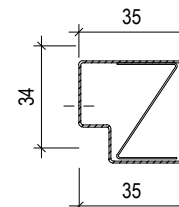

EDGE-PROFILE UW 30
L= max.3000 mm

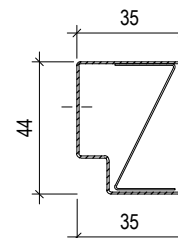

EDGE-PROFILE UW 40
L= max.3000 mm

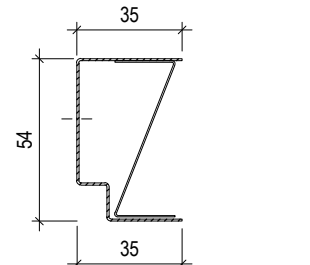

EDGE-PROFILE UW 50
L= max.3000 mm

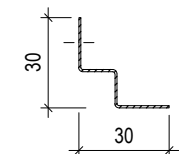

EDGE-PROFILE W 30
L= max.3000 mm

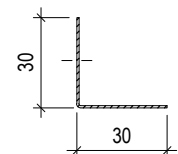

EDGE-PROFILE L 30
L= max.3000 mm

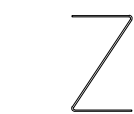

LOCKING-PROFILE 30
L= max.1160 mm



LOCKING-PROFILE 40
L= max.1160 mm



LOCKING-PROFILE 50
L= max.1160 mm